

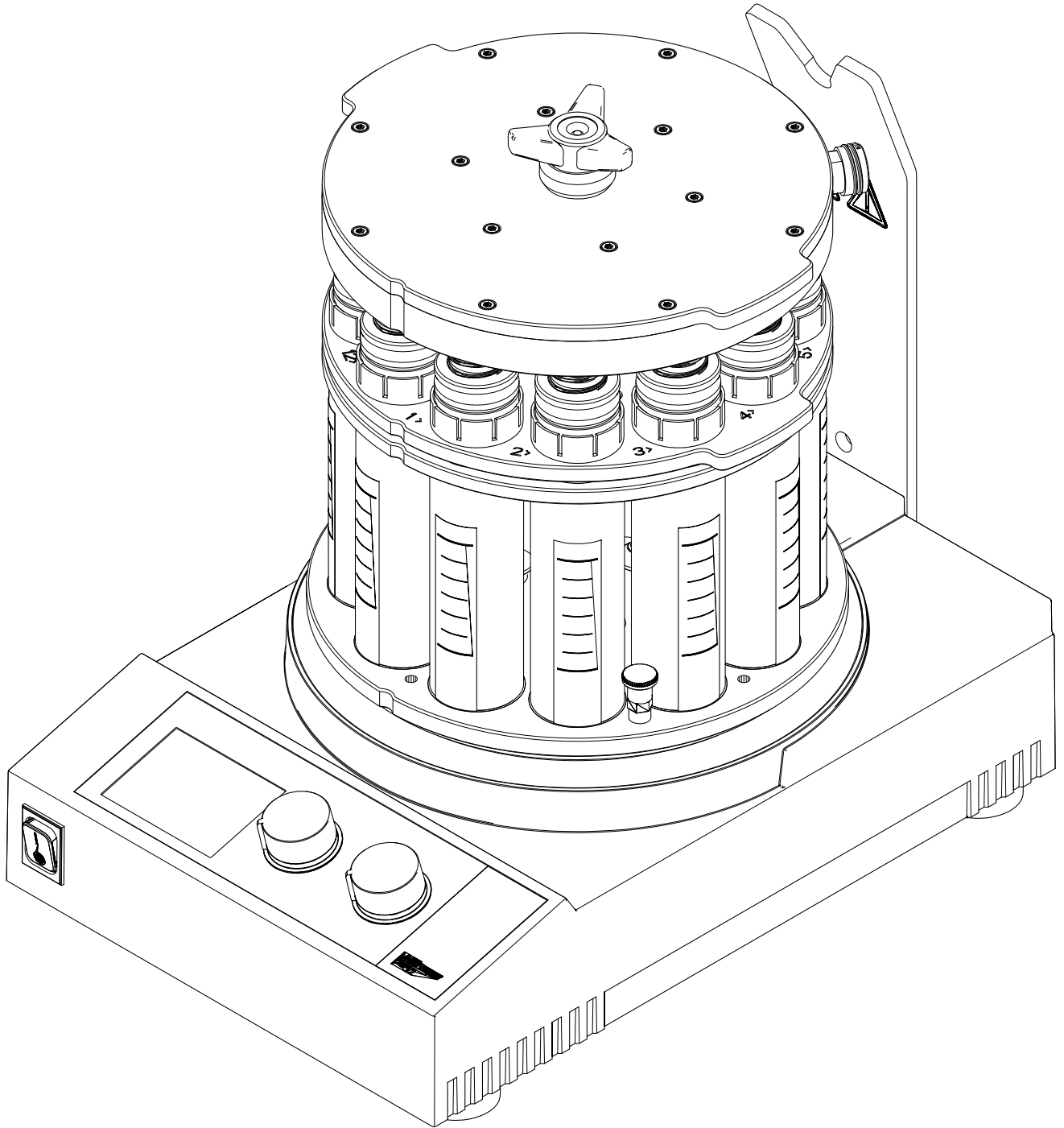

Multivapor™ P-6 / P-12

Operation Manual



Imprint

Product Identification:
Operation Manual (Original), Multivapor™ P-6 / P-12

093156F en

Publication date: 05.2016

BÜCHI Labortechnik AG
Meierseggrasse 40
Postfach
CH-9230 Flawil 1

E-Mail: quality@buchi.com

BUCHI reserves the right to make changes to the manual as deemed necessary in the light of experience; especially in respect to structure, illustrations and technical detail.

This manual is copyright. Information from it may not be reproduced, distributed, or used for competitive purposes, nor made available to third parties. The manufacture of any component with the aid of this manual without prior written agreement is also prohibited.

Table of contents

1	About this manual	6
1.1	Reference documents	6
1.2	Trademarks	6
1.3	Abbreviations	7
2	Safety.	8
2.1	User qualification	8
2.2	Proper use	8
2.3	Improper use	8
2.4	Safety warnings and safety signals used in this manual	9
2.5	Product safety.	11
2.5.1	Instrument-related hazards	11
2.5.2	Other hazards	12
2.5.3	Personal protective equipment	12
2.5.4	Safety elements	13
2.6	General safety rules	13
3	Technical data	14
3.1	Scope of delivery	14
3.1.1	Instrument configurations	14
3.1.2	Ordering matrix	17
3.1.3	Standard accessories	20
3.1.4	Standard accessory glassware	22
3.1.5	Optional accessories	23
3.2	Materials used.	24
3.3	Technical data overview	26
3.4	Solvent table	27

Read this manual carefully before installing and running your system and note the safety precautions in chapter 2 in particular. Store the manual in the immediate vicinity of the instrument, so that it can be consulted at any time.

No technical modifications may be made to the instrument without the prior written agreement of BUCHI. Unauthorized modifications may affect the system safety or result in accidents.

This manual is copyright. Information from it may not be reproduced, distributed, or used for competitive purposes, nor made available to third parties. The manufacture of any component with the aid of this manual without prior written agreement is also prohibited.

The English manual is the original language version and serves as basis for all translations into other languages. Other language versions can be downloaded at www.buchi.com.

4	Description of function	28
4.1	Functional principle of the Multivapor	28
4.1.1	Functional principle of the stand-alone unit	28
4.1.2	Functional principle of the Multivapor-Rotavapor edition	29
4.1.3	Controls of the Multivapor (stand-alone)	30
4.1.4	Display of the Multivapor	30
4.1.5	Rear connections of the Multivapor	31
4.2	Multivapor platform	31
4.3	Crystal rack	32
4.4	Sample preparation rack	32
4.5	Blank adapters (optional)	33
4.6	PE frits	33
4.7	Adapter spring	33
4.8	Sample transfer plate	34
4.9	Vacuum cover	34
4.10	Protective shield (optional)	35
4.11	Condensation (optional)	35
4.12	High-boiling solvents - Woulff bottle (optional)	36
4.13	Vacuum solution (optional)	36
4.14	Connection to a rotary evaporator (optional)	37
4.15	Refrigerated receiver (optional)	37
5	Putting into operation	38
5.1	Installation site	38
5.2	Electrical connections	38
5.3	Commissioning the Multivapor basic instrument	39
5.3.1	Commissioning the crystal rack	39
5.3.2	Assembling the Woulff bottle (optional)	40
5.3.3	Anti-seismic tie-down	40
5.4	Glass assembly	41
5.4.1	Type S and type C condenser	41
5.4.2	Condenser assembly with the refrigerated receiver (optional)	41
5.5	Tube connections	42
5.5.1	Cooling water	42
5.5.2	Vacuum tubes	43
5.6	Commissioning the Multivapor-Rotavapor edition	44
5.7	Functional test	44
5.7.1	Vacuum tightness test	44

6	Operation	46
6.1	Settings at the Multivapor platform	46
6.1.1	Selecting a preset temperature	47
6.1.2	Changing/switching off the preset temperature	47
6.1.3	Setting the rotational speed	47
6.2	Sample preparation	48
6.2.1	Heating up the instrument	48
6.2.2	Sample preparation	48
6.3	Selecting the distillation conditions	50
6.4	Distillation	51
6.5	Optimizing the vacuum conditions (optional)	51
6.5.1	Manual vacuum control and solvent library (V-850 / V-855)	51
6.5.2	Pressure gradients (V-855)	52
6.5.3	Automatic distillation (V-855)	53
6.6	Optimizing the distillation conditions	53
6.7	When the distillation “dies out”	54
6.8	At the end of a run	54
7	Maintenance	55
7.1	Housing	55
7.2	Tube connections and joints	55
7.3	Sealing system	55
7.3.1	Cleaning the seals	55
7.3.2	Replacing the tube adapter seals	56
7.3.3	Replacing the conical adapter O-rings	56
7.3.4	Cleaning the vacuum cover and replacing the corresponding O-rings	57
7.4	Crystal rack	57
7.5	Glass components	59
7.6	PE frits (optional)	59
8	Troubleshooting	60
8.1	Malfunctions and their remedy	60
8.2	Customer service	61
9	Shutdown, storage, transport and disposal	62
9.1	Storage and transport	62
9.2	Disposal	62
9.3	Health and safety clearance form	63
10	Spare parts	64
10.1	Basic instrument	64
10.2	Evaporation unit	65
10.3	Adapter sets	67
10.4	Condenser assemblies	68
10.5	Various glass parts	69
10.6	Miscellaneous	71
11	Declarations and requirements	73
11.1	FCC requirements (for USA and Canada)	73

1 About this manual

This manual describes the Multivapor P-6 and P-12 and provides all information required for its safe operation and to maintain it in good working order.

It is addressed in particular to laboratory personnel and operators.

NOTE

The symbols pertaining to safety (WARNINGS and ATTENTIONS) are explained in chapter 2.

1.1 Reference documents

For information on the Rotavapor, the vacuum controller and the vacuum pump, please refer to the corresponding manuals available in English, German, French, Spanish and Italian:

- Rotavapor R-210 / R-215, Operation Manual numbers 93076–93080
- Vacuum Controller, Operating Manual numbers 93081–93085
- Vacuum Pump, Operating Manual numbers 93090–93094

1.2 Trademarks

The following product names and any registered and unregistered trademarks mentioned in this manual are used for identification purposes only and remain the exclusive property of their respective owners:

ASE® is a registered trademark of Dionex Corporation

- Multivapor™ is a trademark of BÜCHI Labortechnik AG
- Rotavapor® is a registered trademark of BÜCHI Labortechnik AG

1.3 Abbreviations

Chemicals:

EPDM: Ethylenepropylenedimonomer

FEP: Combination of tetrafluoroethylene and hexafluoropropylene

FFKM: Perfluoro caoutchouc

FKM: Fluoric caoutchouc

PBT: Polybutyleneterephthalate

PE: Polyethylene

PEEK: Polyetheretherketone

PET(P): Polyethyletherphtalate

PETP: Polyethyltereophthalate

PFA: Perfluoroalkoxy

PTFE: Polytetrafluoroethylene

PUT: *Polyurethane*

Miscellaneous:

rpm: revolutions per minute

P+G: PLASTIC+GLAS is a unique protective layer for glass components. It offers improved mechanical rupture resistance and increases protection against broken glass whilst ensuring no sample is lost in the event of the receiving flask being damaged.

2 Safety

This chapter highlights the safety concept of the Multivapor and contains general rules of behavior and warnings from hazards concerning the use of the product.

The safety of users and personnel can only be ensured if these safety instructions and the safety-related warnings in the individual chapters are strictly observed and followed, therefore, the manual must always be available to all persons performing the tasks described herein.

2.1 User qualification

The instrument may only be used by laboratory personnel or other persons who on account of training or professional experience have an overview of the dangers which can develop when operating the instrument.

Personnel without this training or persons who are currently being trained require careful supervision. The present Operation Manual serves as a basis for training.

2.2 Proper use

The instrument has been designed and built for laboratory use only. It serves for activities associated with the parallel evaporation of multiple samples by means of heating under vacuum, with or without regulation by a vacuum controller. The vacuum is typically applied by a PTFE diaphragm vacuum pump.

Alternatively, the instrument can be used in combination with a rotary evaporator. In this case the Multivapor serves as an accessory and is connected via an interface to the condenser of the Rotavapor.

2.3 Improper use

Applications beyond those described above are improper. Furthermore, applications which do not comply with the technical data are also considered improper. The operator bears the sole risk for any damages caused by such improper use.



The following applications are expressly forbidden:

- Use of the instrument in rooms which require ex-protected instruments.
- Use as a calibrating instrument for other instruments.
- Preparation of samples which can explode or inflame due to shock, friction, heat or spark formation.
- Use in high pressure situations.
- Processing of hard, brittle and abrasive materials (e.g. stones, sherds, soil samples, etc.) which may destruct the sample tubes.
- Use of the instrument for digestions (e.g. Kjeldahl).

2.4 Safety warnings and safety signals used in this manual

DANGER, WARNING, CAUTION and NOTICE are standardized signal words for identifying levels of hazard seriousness of risks related to personal injury and property damage. All signal words, which are related to personal injury are accompanied by the general safety sign.

For your safety it is important to read and fully understand the below table with the different signal words and their definitions!

Sign	Signal word	Definition	Risk level
	DANGER	Indicates a hazardous situation which, if not avoided, will result in death or serious injury.	★★★★★
	WARNING	Indicates a hazardous situation which, if not avoided, could result in death or serious injury.	★★★★☆
	CAUTION	Indicates a hazardous situation which, if not avoided, may result in minor or moderate injury.	★★★☆☆
no	NOTICE	Indicates possible property damage, but no practices related to personal injury.	★☆☆☆☆ (property damage only)

Supplementary safety information symbols may be placed in a rectangular panel on the left to the signal word and the supplementary text (see below example).















Space for supplementary safety information symbols.	 SIGNAL WORD
	Supplementary text, describing the kind and level of hazard / risk seriousness. <ul style="list-style-type: none"> List of measures to avoid the herein described hazard or hazardous situation.

Table of supplementary safety information symbols

The below reference list incorporates all safety information symbols used in this manual and their meaning.

Symbol	Meaning
	General warning
	Electrical hazard

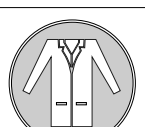
Symbol	Meaning
	Explosive gases, explosive environment
	Harmful to life-forms
	Hot item, hot surface
	Explosive substance
	Device damage
	Inhalation of substances
	Flammable substances
	Fragile items / content
	Do not dispose of in household trash
	Wear protective mask
	Wear laboratory coat

Symbol	Meaning
	Wear protective goggles
	Wear protective gloves

Additional user information

Paragraphs starting with NOTE transport helpful information for working with the device/software or its supplementaries. NOTEs are not related to any kind of hazard or damage (see example below).

NOTE

Useful tips for the easy operation of the instrument/software.

2.5 Product safety

The Multivapor is designed and built in accordance with current state-of-the-art technology, however, risks to users, property, and the environment can arise when the instrument is used carelessly or improperly.





The manufacturer has determined residual dangers emanating from the instrument



- if the instrument is operated by insufficiently trained personnel.
- if the instrument is not operated according to its proper use.



Appropriate warnings in this manual serve to make the user alert to these residual dangers.

2.5.1 Instrument-related hazards

Pay attention to the following safety notices:

 	<p>CAUTION</p> <p>Risk of minor or moderate burns when handling hot parts.</p> <ul style="list-style-type: none"> • Do not touch hot parts or surfaces (especially the heating plate with up to 95 °C)
  	<p>WARNING</p> <p>Death or serious injuries by formation of explosive atmospheres (peroxides) inside the instrument.</p> <ul style="list-style-type: none"> • Directly withdraw released fumes and gaseous substances by sufficient ventilation at filling • Before operation, check all gas connections for correct installation • Establish inert system atmosphere before processing substances that can form explosive or reactive gases or powders • Check for proper earth connection to lead off electrostatic charges

 	NOTICE
	<p>Risk of glass breakage by excessive strains.</p> <ul style="list-style-type: none"> • Mount all glassware parts without strains • Check glassware for proper fixing regularly and readjust fixing points if necessary • Do not use defective glassware • Use the protective shield (optional)







 	NOTICE
	<p>Risk of instrument damage by wrong mains supply.</p> <ul style="list-style-type: none"> • External mains supply must meet the voltage given on the type plate • Check for sufficient grounding

2.5.2 Other hazards

	WARNING
	<p>Death or serious burns by flammable vapors.</p> <ul style="list-style-type: none"> • Remove all sources of flammable vapors • Do not store flammable chemicals in the vicinity of the device

2.5.3 Personal protective equipment

Always wear personal protective equipment such as protective eye goggles, protective clothing and gloves. The personal protective equipment must meet all requirements of the supplementary data sheets for the chemicals used.

     	WARNING
	<p>Death or serious poisoning by contact or incorporation of harmful substances.</p> <ul style="list-style-type: none"> • Wear safety goggles • Wear safety gloves • Wear a laboratory coat

2.5.4 Safety elements

Electronics

- The heating plate is equipped with an electronic over-temperature protection. It controls the temperature limit (the actual heating plate temperature may not exceed the set temperature by 2 °C for more than 2 minutes) and the function of the temperature sensor.
- The heating plate is equipped with safety fuses.

Parts in direct contact with the instrument

- Combi clip for fixing the vacuum joint.
- Ball joint clip for safe fixing of the receiving flask.
- Rods and holder for attaching the condensation assemblies.

Glass

- Use of high quality, inert 3.3 borosilicate glass.
- Use of tube clips GL14 for preventing glass breakage.
- PLASTIC+GLAS (P+G) is a unique protective layer for glass components. It offers improved mechanical damage resistance and increases protection against broken glass. It also makes sure that the solvent in the receiving flask is not spilled, if the flask is damaged. All glass parts of the condenser assembly are P+G coated.

Anti-seismic tie-down

- The instrument is equipped with a tie-down to fix it in the event of an earthquake.
- Optional
- The protective shield (optional but recommended accessory) protects operators in case of accidents from broken glass, solvent splashes, hot water, explosion or implosion.

2.6 General safety rules

Responsibility of the operator

The head of laboratory is responsible for training his personnel.

The operator shall inform the manufacturer without delay of any safety-related incidents which might occur during the operation of the instrument. Legal regulations, such as local, state and federal laws applying to the instrument must be strictly followed.

Duty of maintenance and care

The operator is responsible for ensuring that the instrument is only operated in proper manner and that maintenance, service, and repairs are performed with care, on schedule and by authorized personnel only.

Spare parts to be used

Use only recommended consumables and spare parts for maintenance to ensure continued optimum system performance and reliability. Any modifications to the spare parts used are only allowed with the prior written permission of the manufacturer.

Modifications

Modifications to the instrument are only permitted after prior consultation with and written approval obtained from the manufacturer. Modifications and upgrades should only be carried out by an authorized BUCHI technical engineer. The manufacturer reserves the right to decline any claim resulting from unauthorized modifications.

3 Technical data

This chapter introduces the reader to the Multivapor and its main components. It contains technical data, requirements and performance data.

3.1 Scope of delivery

Check the scope of delivery according to the order number.

NOTE

For detailed information on the listed products, see www.buchi.com or contact your local dealer.

3.1.1 Instrument configurations

The Multivapor is a compact parallel evaporation system with either 6 or 12 position, referred to as Multivapor P-6 or Multivapor P-12, respectively. Both setups are available in different configurations implying peripherals such as condenser units, vacuum pumps/controllers and a rotary evaporator interface.

Multivapor Basic

Multivapor platform with the crystal rack, vacuum cover, tube adapters, transfer and sample preparation rack, P+G coated condenser and receiving flask.

**Table 3-1: Items included in the Basic configuration**

Product	Order number
Multivapor platform	
220–240 V	–
100–120 V	–
Crystal rack	
P-6	11057500
P-12	11057505
Vacuum cover	
P-6	49773
P-12	49615
Tube adapters	
BUCHI Standard P-6 (6 pieces)	11056598
BUCHI Standard P-12 (12 pieces)	11057082
Glassware	
BUCHI Standard vessel P-6 (6 pieces)	49774
BUCHI Standard vessel P-12 (25 pieces)	49662
Transfer rack	
P-6	49250
P-12	49251
Sample preparation rack	
P-6	49783
P-12	49755
Condenser unit, P+G coated	
type S, 1 L	48889
type S, 2 L	48890
type C, 1 L	48887
type C, 2 L	48888

Multivapor Professional

The difference between the EasyVac and the Professional configuration is that the latter comprises an additional secondary condenser for the vacuum pump and the vacuum controller V-855.

**Table 3-3: Items included in the Professional configuration**

Product	Order number
Multivapor P-6 / P-12 Basic	–
V-700 / V-855, Woulff bottle and secondary post pump condenser (type according to the primary condenser)	71311 or 71312

Multivapor Rotavapor

In contrast to the stand-alone configurations described before, this setup is connected to an already installed rotary evaporator. Delivery therefore includes the Multivapor with a Rotavapor set to combine it with the condenser of the rotary evaporator.



Table 3-4: Items included in the Rotavapor configuration

Product	Order number
Multivapor platform	
220–240 V	–
100–120 V	–
Crystal rack	
P-6	11057500
P-12	11057505
Vacuum cover	
P-6	49773
P-12	49615
Tube adapters	
BUCHI Standard P-6 (6 pieces)	11056598
BUCHI Standard P-12 (12 pieces)	11057082
Glassware	
BUCHI Standard vessel P-6 (6 pieces)	49774
BUCHI Standard vessel P-12 (25 pieces)	49662
Transfer rack	
P-6	49250
P-12	49251
Sample preparation rack	
P-6	49783
P-12	49755
Rotavapor adapter set	48740

NOTE

The Rotavapor is not included in the Rotavapor configuration.

3.1.2 Ordering matrix

In this section the items accessible by the ordering matrix are listed.

NOTE

The standard plastic material is PETP, however, for very harsh conditions such as trifluoric acid (TFA) PEEK is available as a highly resistant alternative. In this case configure the system without evaporation unit and tube adapters (position „00“ in the matrix section „evaporation unit“) and order the corresponding items separately as accessory.

Order number:

MP		x	x	x	x	x	x	x
----	--	---	---	---	---	---	---	---



Number of sample positions

Product

1: Multivapor P-12

2: Multivapor P-6

Order number:

MP	x		x	x	x	x	x	x
----	---	--	---	---	---	---	---	---



Voltage

Product

1: 220–240 V

2: 100–120 V

Order number:

MP	x	x	1	x	x	x	x	x
----	---	---	---	---	---	---	---	---



Order number:

MP	x	x	x			x	x	x
----	---	---	---	--	--	---	---	---



Protective shield

Product	Order number
Protective shield P-6, P-12	48784

Evaporation unit, tube adapter, glassware

Product
01: Configuration with evaporation unit (i.e. crystal rack and vacuum cover), set of tube adapters for BUCHI's standard sample tubes, preparation/transfer rack, set of BUCHI's standard sample tubes (∅ 60 mm for P-6, ∅ 25 mm for P-12).

99: Configuration with evaporation unit but without tube adapters and glassware. The corresponding adapters have to be ordered separately according to the Multivapor Adapter Guide.

00: Configuration without evaporation unit, without preparation/transfer rack and without adapters and glassware. This is the recommended choice to set up a PEEK system instead of a PETP system. The corresponding items have to be ordered separately as accessory (not via the ordering matrix).

Order number:

MP	x	x	x	x	x			x
----	---	---	---	---	---	--	--	---

**Condenser assembly, P+G coated**

Product	Order number
---------	--------------

Type S condenser for tap water or a recirculating chiller.

S1: Condenser with 1 L receiving flask	48889
--	-------

S2: Condenser with 2 L receiving flask	48890
--	-------

Type C condenser (cold trap) for dry-ice cooling:

C1: Cold trap with 1 L receiving flask	48887
--	-------

C2: Cold trap with 2 L receiving flask	48888
--	-------

R0: Rotavapor adapter set	48740
---------------------------	-------

Order number:

MP	x	x	x	x	x	x	x	
----	---	---	---	---	---	---	---	--



Vacuum solution

Product	Order number
Comprises a Wouff bottle to trap particles and droplets before the vacuum inlet.	
V-700, V-855 with secondary condenser	71311 or
according to the type of the primary condenser	71312

3.1.3 Standard accessories

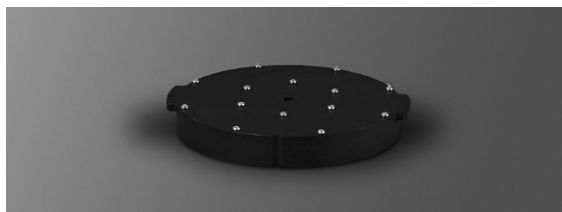
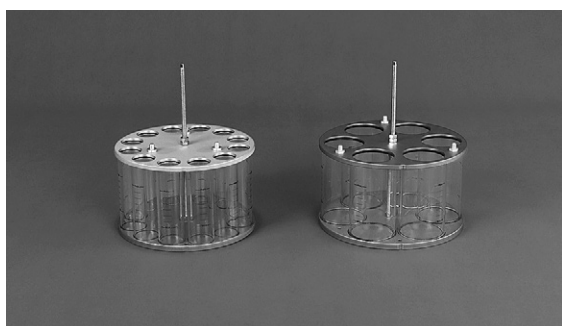
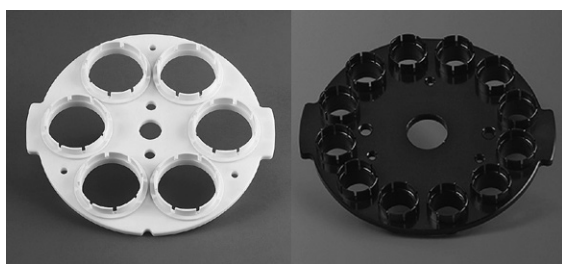

Table 3-5: Standard accessories

Product	Order number
Crystal rack P-6	11057500
Crystal rack P-12	11057505
Vacuum cover P-6, PETP*	49773
Vacuum cover P-6, PEEK**	49710
Vacuum cover P-12, PETP*	49615
Vacuum cover P-12, PEEK**	48845
*equipped with EPDM O-rings (FKM enclosed)	
**equipped with FFKM O-rings	

**Table 3-5: Standard accessories (cont.)**

Product	Order number
Sample preparation rack P-6	49783
Sample preparation rack P-12	49755
Transfer plate P-6	49251
Transfer plate P-12	49250
Transfer plate P-6 for P-12 adapter	11055146

Table 3-6: Multivapor adapter P-12

Product	Order number
Adapter carrier PETP	11057171
Adapter carrier PEEK	11057179
Set of 12 gaskets	11057468
Multivapor and Syncore tool	11057214

Table 3-7: Documentation

Product	Order number
Application booklet	48858
Installation/Operation guide	93163
Multivapor IQ/OQ, English	48822
Operation Manual:	
English	93156
German	93157
French	93158
Italian	93159
Spanish	93160

3.1.4 Standard accessory glassware

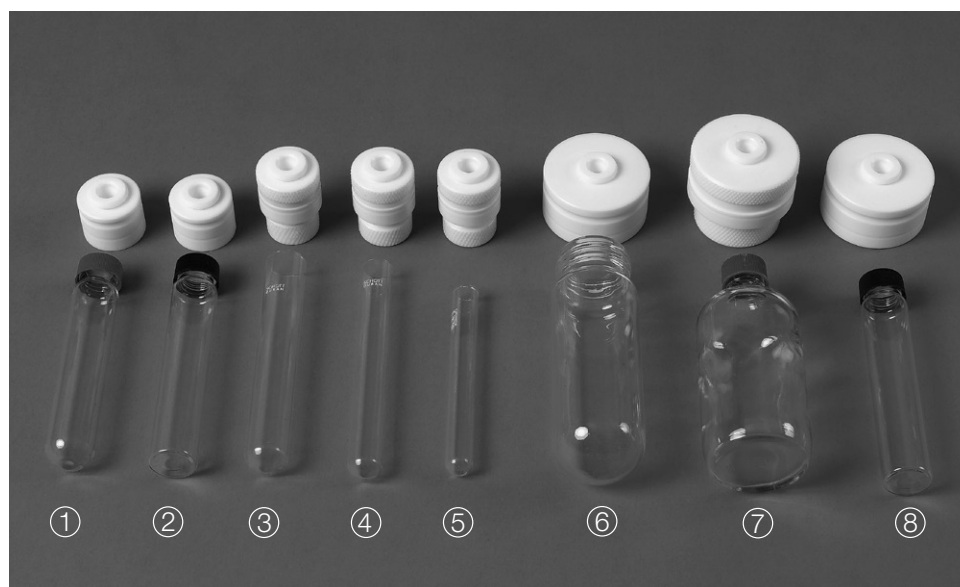

Fig. 3.1: Overview over the available BUCHI glassware and the corresponding adapters

	Sample tubes available from BUCHI	Adapter set (12) **		Seals **
		PETP	PEEK	
P-12	① BUCHI tube P-12, 60 mL (25 pcs)	49662	11057082 11057178	11057468 (12)
	② ASE/PSE tube, 60 mL (72 pcs)	49535	11057082 11057178	11057468 (12)
	③ Test tube \varnothing 25 mm (50 pcs)	38469	48873 *	49733 (12)
	④ Test tube \varnothing 20 mm (100 pcs)	42845	48778 *	48779 (12)
	⑤ Test tube \varnothing 16 mm (100 pcs)	38543	48770 *	48773 (12)
P-6	⑥ BUCHI tube P-6, 220 mL (6 pcs)	49774	11056598 11057243	11057469 (6)
	⑦ ASE/PSE tube, 240 mL (10 pcs)	52672	11056585 *	48853 (12)
	⑧ ASE/PSE tube, 60 mL (72 pcs)	49535	11056585 *	48853 (12)

*available on request

**number of items included in the set given in brackets

3.1.5 Optional accessories

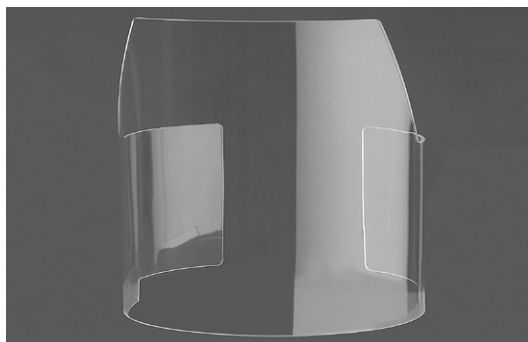

Table 3-8: Optional accessories

Product	Order number
Protective shield P-6 / P-12	48784

Set of 60 PE frits P-6 / P-12, \varnothing 10 mm	44856
--	-------

Blank adapters to close vacant positions

P-6, PETP, 6 pieces	49729
P-6, PEEK, 6 pieces	49730
P-12, PETP, 12 pieces	48791
P-12, PEEK, 12 pieces	48796

Set of Woulff bottle including holder and tube	11057282
--	----------

Spare glass for Woulff bottle	11056926
-------------------------------	----------

Spare tube	11057283
------------	----------

Set of 1 gasket and 1 O-ring for Woulff bottle	11057990
--	----------

**Table 3-8: Optional accessories (cont.)**

Product	Order number
F-100, 230 V; 50/60 Hz (400 W)	11056460
F-100, 115 V; 50/60 Hz (400 W)	11056461
F-108, 230 V; 50/60 Hz (800 W)	11056464
F-108, 115 V; 50/60 Hz (800 W)	11056465

3.2 Materials used

Table 3-9: Materials used

Component	Material designation
Housing Multivapor	PUT foam
Heating plate	Aluminium, anodized
Protective ring heating plate	EPDM
Crystal rack	Aluminium, borosilicate glass
Standard tube adapters	PETP
PEEK tube adapters	PEEK
Seals for tube adapters	PTFE
Standard vacuum cover	PETP
Alternative vacuum cover	PEEK
Vacuum cover seal	EPDM
O-ring for the vacuum cover adapter	EPDM and FKM or FFKM (optional)
Vacuum tube	Ribbed PFA with PTFE seals
Protective shield	Polycarbonate

Table 3-10: Range of application for the O-rings of the conical adapters

	EPDM	FKM	FFKM	PEEK	PET(P)	PFA	PTFE
Acetaldehyde	B	D	A	A	A	A	A
Acetic acid	A	B	A	A	A	A	A
Acetic acid anhydride	B	D	A	A	A	A	A
Acetone	A	D	A	A	B	A	A
Benzene	D	A	A	A	A	A	A
Butanol	B	A	A	A	B	A	A
Chloroform	D	A	A	A	B	A	A
Diethyl ether	C	C	A	A	A	A	A
Dimethylformamide	A	-	A	A	B	A	A
Dimethylbenzene (Xylol)	D	A	A	A	A	A	A
Dioxane	B	-	A	A	A	A	A
Ethanol	A	A	A	A	A	A	A
Ethyl acetate	B	D	A	A	-	A	A
Hexane	C	A	A	A	A	A	A
Isobutanol	A	A	A	A	A	A	A
Isopropanol	A	A	A	A	A	A	A
Methanol	A	B	A	A	A	A	A
Methylene chloride	D	A	A	A	D	A	A
Nitrobenzene	C	B	A	B	D	A	A
Phenol	B	A	A	B	C	A	A
Propanol	A	A	A	A	A	A	A
Sulphuric acid, fuming	C	A	A	C	C	A	A
Carbon tetrachloride	D	A	A	A	A	A	A
Tetrahydrofurane	B	D	A	A	A	A	A
Toluene	D	A	A	A	A	A	A
Triethylamine	C	A	A	A	-	-	-
Trichloroethane	D	A	A	A	A	-	-
Trichloroacetic acid	B	-	-	A	-	A	A
Vinylidene chloride	D	-	A	A	B	-	-
Aq. HBr, sat.	B	A	A	C	-	A	A
Aq. HCl, sat.	A	A	A	B	A	A	A
Aq. ammonia solution	A	D	A	A	A	A	A
Aqueous caustic soda	A	B	A	A	B	A	A
Aqueous nitric acid	B	A	A	B	B	A	A

*A: very good resistance, B: moderate resistance, C: poor resistance, D: very poor resistance

NOTE

Table 3-10 refers to the chemical resistance of the solid material in liquids. However, the resistance against the corresponding vapors is significantly better. Tabled values may vary by changing temperature and pressure.

The PETP vacuum cover is equipped with EPDM O-rings. A set of 12 FKM O-rings is enclosed. Alternatively, there are highly resistant FFKM O-rings available. The PEEK vacuum cover is equipped with FFKM O-rings by default.

3.3 Technical data overview

Table 3-11: Technical data	
Dimensions (W×H×D)	270×400×400 mm
Weight	P-6: 22 kg, P-12: 21 kg
Connection voltage	100 – 120 or 220 – 240 VAC ± 10%
Fuse	T 3.1 A L 250 V (220–240 V) T 6.3 A L 250 V (100–120 V)
Power consumption	max. 800 W
Mains connection	3-pole (P, N, E) via power cord
Frequency	50/60 Hz
Installation category	II
Degree of protection	IP21
Pollution degree	2
Rotation speed range	P-6: 0– 370 rpm, P-12: 0 – 485 rpm
Temperature control range	20 – 95 °C
Temperature accuracy	± 3 °C (instrument calibrated at 20 °C)
Display	Set and actual temperature
Max. size of sample tube	P-6: OD 16 – 60 mm, L = 110 – 150 mm; P-12: OD 15 – 30 mm, L = 15 – 150 mm
Max content of sample tube	P-6: 160 mL, P-12: 30 mL
Environmental conditions	for indoor use only
Temperature	5 – 40 °C
Altitude	up to 2000 m
Humidity	maximum relative humidity 80% for temperatures up to 31 °C, and then linearly decreasing to 50% at 40 °C
Temperature resistance P+G	ca. -70 °C – 60 °C
Temperature resistance P+G low temperature	-80 °C – 50 °C
Temperature resistance protective shield	< 160 °C

3.4 Solvent table

Table 3-12: Solvent table						
Solvent	Formula	Molar mass in g / mol	Evaporation energy in J / g	Boiling point at 1013 mbar	Density in g / cm ³	Vacuum in mbar for boiling point at 40 °C
Acetone	C ₃ H ₆ O	58.1	553	56	0.790	556
<i>n</i> -Amylalcohol, <i>n</i> -pentanol	C ₅ H ₁₂ O	88.1	595	37	0.814	11
Benzene	C ₆ H ₆	78.1	548	80	0.877	236
<i>n</i> -Butanol, <i>tert</i> -butanol	C ₄ H ₁₀ O	74.1	620	118	0.810	25
2-Methyl-2-propanol	C ₄ H ₁₀ O	74.1	590	82	0.789	130
Chlorobenzene	C ₆ H ₅ Cl	112.6	377	132	1.106	36
Chloroform	CHCl ₃	119.4	264	62	1.483	474
Cyclohexane	C ₆ H ₁₂	84.0	389	81	0.779	235
Diethylether	C ₄ H ₁₀ O	74.0	389	35	0.714	850
1,2-Dichloroethane	C ₂ H ₄ Cl ₂	99.0	335	84	1.235	210
1,2-Dichloroethylene (<i>cis</i>)	C ₂ H ₂ Cl ₂	97.0	322	60	1.284	479
1,2-Dichloroethylene (<i>trans</i>)	C ₂ H ₂ Cl ₂	97.0	314	48	1.257	751
Diisopropyl ether	C ₆ H ₁₄ O	102.0	318	68	0.724	375
Dioxane	C ₄ H ₈ O ₂	88.1	406	101	1.034	107
DMF (dimethylformamide)	C ₃ H ₇ NO	73.1		153	0.949	11
Acetic acid	C ₂ H ₄ O ₂	60.0	695	118	1.049	44
Ethanol	C ₂ H ₆ O	46.0	879	79	0.789	175
Ethylacetate	C ₄ H ₈ O ₂	88.1	394	77	0.900	240
Heptane	C ₇ H ₁₆	100.2	373	98	0.684	120
Hexane	C ₆ H ₁₄	86.2	368	69	0.660	360
Isopropylalcohol	C ₃ H ₈ O	60.1	699	82	0.786	137
Isoamylalcohol-3-methyl-1-butanol	C ₅ H ₁₂ O	88.1	595	129	0.809	14
Methylethylketone	C ₄ H ₈ O	72.1	473	80	0.805	243
Methanol	CH ₄ O	32.0	1227	65	0.791	337
Methylene chloride, dichloromethane	CH ₂ Cl ₂	84.9	373	40	1.327	850
Pentane	C ₅ H ₁₂	72.1	381	36	0.626	850
<i>n</i> -Propylalcohol	C ₃ H ₈ O	60.1	787	97	0.804	67
Pentachloroethane	C ₂ HCl ₅	202.3	201	162	1.680	13
1,1,2,2-Tetrachloroethane	C ₂ H ₂ Cl ₄	167.9	247	146	1.595	35
Tetrachlorocarbon	CCl ₄	153.8	226	77	1.594	271
1,1,1-Trichloroethane	C ₂ H ₃ Cl ₃	133.4	251	74	1.339	300
Tetrachloroethylene	C ₂ Cl ₄	165.8	234	121	1.623	53
THF (tetrahydrofuran)	C ₄ H ₈ O	72.1		67	0.889	357
Toluene	C ₇ H ₈	92.2	427	111	0.867	77
Trichloroethylene	C ₂ HCl ₃	131.3	264	87	1.464	183
Water	H ₂ O	18.0	2261	100	1.000	72
Xylene (mixture)	C ₈ H ₁₀	106.2	389			25
<i>o</i> -Xylene	C ₈ H ₁₀	106.2		144	0.880	
<i>m</i> -Xylene	C ₈ H ₁₀	106.2		139	0.864	
<i>p</i> -Xylene	C ₈ H ₁₀	106.2		138	0.861	

4 Description of function

This chapter explains the basic principle of the Multivapor P-6 and P-12 and provides a functional description of the assemblies.

4.1 Functional principle of the Multivapor

The Multivapor is a 6 or 12 position parallel evaporator for simultaneous evaporation of up to 6×150 mL or 12×30 mL sample volume, referred to as Multivapor P-6 or Multivapor P-12, respectively. The basis of this procedure is solvent evaporation and condensation in vacuo using orbital horizontal movement to produce a strong vortex in each sample tube. Distillation is usually performed under vacuum to increase performance and reduce the boiling temperature preventing sample decomposition.

The Multivapor is available as a stand-alone unit or in combination with a rotary evaporator, providing a clever synergy enhancing solution by having two instruments, the Multivapor and the Rotavapor, share the same condenser and vacuum assembly. The two configurations Multivapor P-6 and Multivapor P-12 are not interchangeable as the orbital movement of the platform is different in order to guarantee a smooth and safe operation.

4.1.1 Functional principle of the stand-alone unit

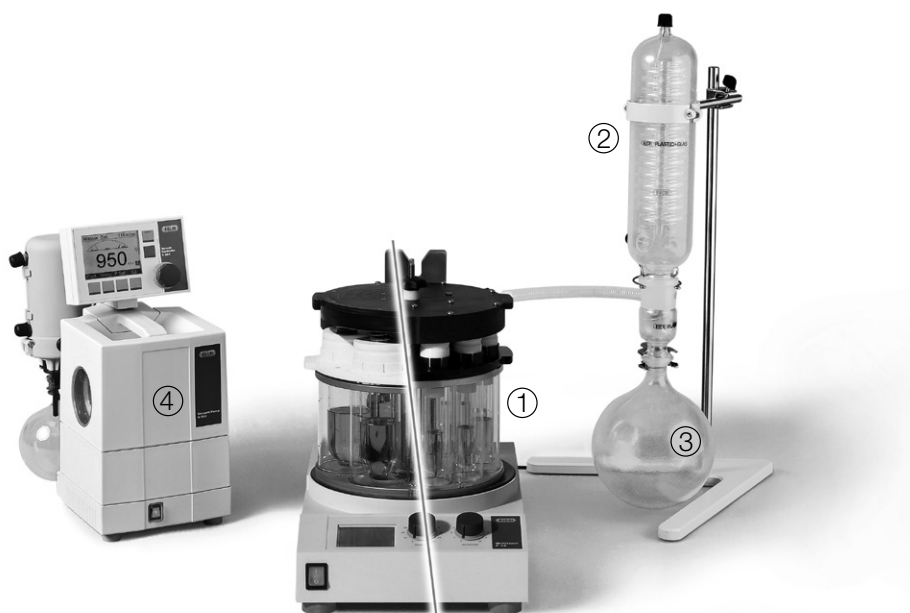

Fig. 4.2: Overview of the stand-alone edition. The two different Multivapor configurations - Multivapor P-6 and Multivapor P-12 - are indicated by intersecting the figure.

① Evaporation area

The solvent is heated by means of a heating plate. Horizontal orbital movement of the heating plate results in a thorough vortex of the mixture within the test tubes. Thus, the solvent surface is increased which in turn leads to a higher evaporation rate and reduction of boiling retardation.

② Cooling area

Each sample is individually connected to the vacuum cover with glassware specific adapters. The vapor is collected and then transferred to the condenser via a ribbed PFA vacuum tube. In the condenser the heat required for transmitting the solvent from the liquid into the gas phase is transferred to the coolant. Water, dry-ice in acetone or any coolant suitable for a recirculating chiller is typically used for this purpose.

③ Receiving flask

The condensed vapor is collected in the receiving flask. It is recommended to empty the flask after each run. For evaporation of solvent mixtures or at low temperatures an optional refrigerated receiver is recommended to prevent re-evaporation of the condensate. This reduces the evaporation time and prevents interruption between runs.

④ Vacuum

The evaporation performance is dependant on the pressure, the temperature of the solvent and the coolant, and the vortex. In order to evaporate solvent at a given temperature and revolution, pressure needs to be reduced accordingly via a vacuum pump. A vacuum controller regulates the pump by continuously reducing the vacuum until the set point is reached. This task is performed either manually or automatically.

4.1.2 Functional principle of the Multivapor-Rotavapor edition

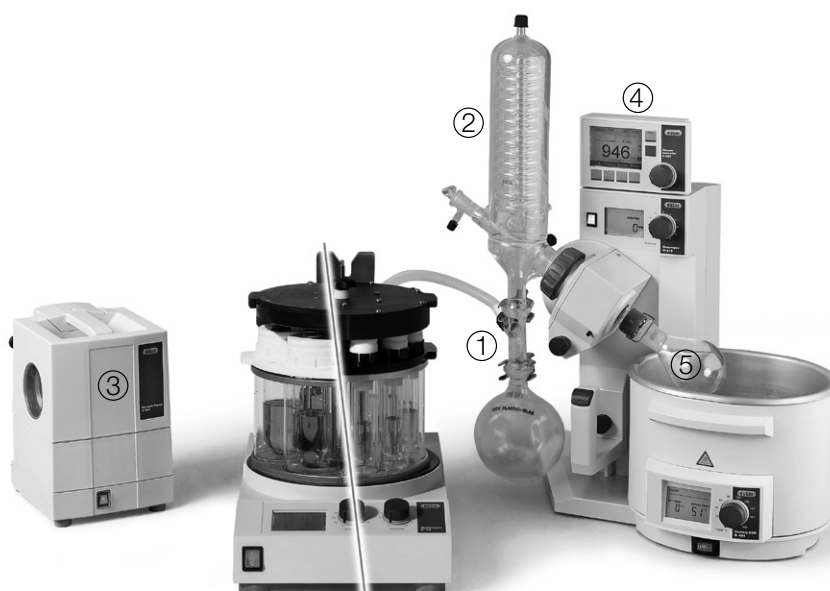

Fig. 4.3: Combination of the Multivapor P-6/P-12 with the Rotavapor R-215

The vacuum tube of the Multivapor is connected to the T-piece ① which is installed between the condenser and receiver of the Rotavapor. The key feature of this setup is that the condenser assembly ②, the vacuum pump ③ and the vacuum controller ④ are shared between both the Multivapor and the Rotavapor. Therefore both single evaporation of large flasks and parallel evaporation of small test tubes is achievable with the same setup using little space. However, simultaneous performance of both tasks is neither feasible nor advisable due to physical reasons, as the cooling capacity of the

condenser cannot cope with the amount of vapor produced. During operation of the Multivapor, the Rotavapor side has to be closed using an empty evaporation flask ⑤.

4.1.3 Controls of the Multivapor (stand-alone)



- ① Main switch
- ② Temperature display
- ③ Knob for temperature regulation
- ④ Knob for rotational speed
- ⑤ Holder for the vacuum cover

Fig. 4.4: Overview of the Multivapor controls

4.1.4 Display of the Multivapor

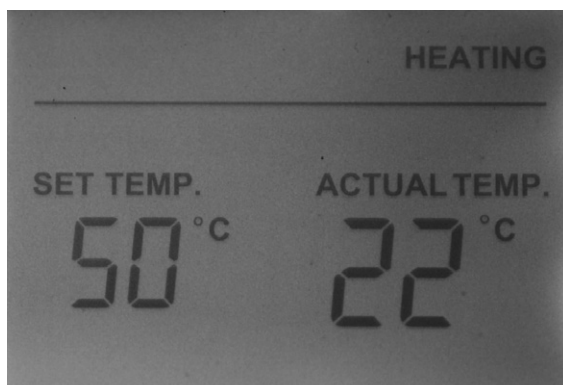

The display shows both the actual and the set temperatures. If the actual temperature is below the set temperature, the indication "heating" appears.

Fig. 4.5: Display of the Multivapor

4.1.5 Rear connections of the Multivapor

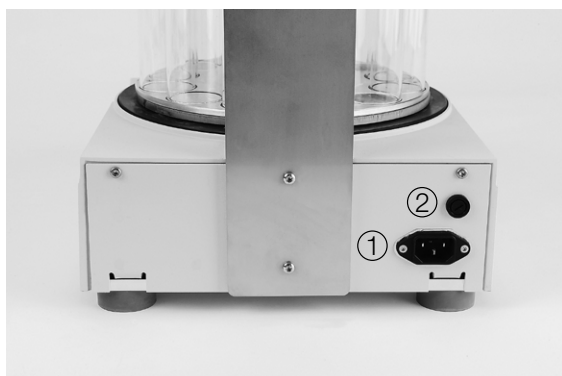

- ① Mains supply
- ② Main fuse

Fig. 4.6: Rear connection of the Multivapor

4.2 Multivapor platform



Fig. 4.7: Multivapor platform

The platform is available with a 220 – 240 V and a 100 – 120 V power supply. The temperature and orbital movement of the heating plate are individually adjusted via the corresponding control knobs. The temperature is limited to 95 °C to prevent evaporation of water which is used as heat transfer medium. Both the set and actual temperature of the heating plate are shown in the display.

The horizontal orbital speed of the heating plate is indicated by a graduation (0...10) and ranges from 0 to 370 rpm for the Multivapor P-6, or 0 to 485 rpm for the Multivapor P-12.

A black rubber gasket ① prevents contamination of the instrument interior with liquids.

4.3 Crystal rack



Fig. 4.8: Multivapor with the crystal rack

The crystal rack ① is fixed onto the heating plate and operates as a heat transition between the heating plate and the sample tubes. It comprises 6 or 12 glass cylinders accommodated circularly to provide full supervision. A level indication designates the optimal filling level for water, which serves as the heating medium. A further advantage of the crystal rack compared to the widely used metal racks is the compatibility with all kind of sample tubes differing in shape, diameter and length.

4.4 Sample preparation rack

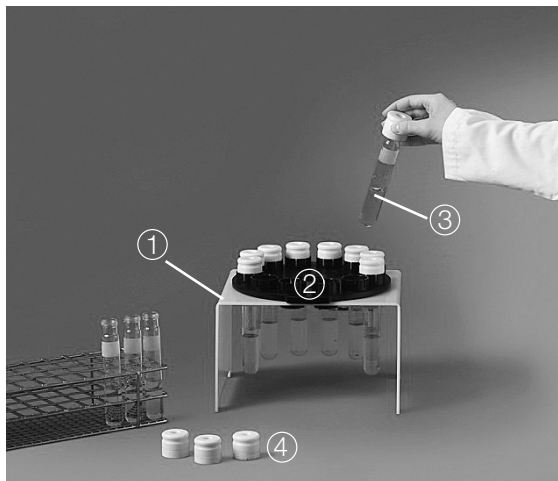

Fig. 4.9: Sample preparation rack with the transfer plate and test tubes with the corresponding adapters

The sample preparation rack ① serves as support for the transfer rack ② including 6 or 12 sample tubes ③.

The tubes are equipped with specific adapters ④ which seal the test tubes effectively with the vacuum cover.

4.5 Blank adapters (optional)



Fig. 4.10: Blank adapters

If less than the maximum number of samples are being evaporated, the vacant positions need to be occupied either with empty sample tubes or with the optional blank adapters. These adapters consist of a closed bottom side but the same outer dimensions as the standard adapters.

It is not necessary to distribute the samples equally across the crystal rack. It is therefore possible to accommodate the front positions with the samples and the back positions with the blank adapters.

For very harsh conditions, such as evaporation of trifluoro acetic acid (TFA), the adapters are also available in PEEK.

4.6 PE frits



Fig. 4.11: PE frits

In order to reduce contamination of the vacuum cover by foaming samples or boiling retardation, an optional porous PE frit can be placed into the tube adapters closing the vapor duct. This measure also allows sample adsorption onto silica for chromatographic purposes (dry loading) by retaining the silica inside the tube.

4.7 Adapter spring



Fig. 4.12: Adapter spring

Springs on the top of the tube adapters are optionally used to facilitate the opening of the vacuum cover.

4.8 Sample transfer plate



Fig. 4.13: Simultaneous sample transfer using the transfer plate

As the test tubes are tightly fixed to the transfer plate, the whole assembly is transferred at once into the crystal rack. This allows a preceding equilibration of the instrument.

4.9 Vacuum cover



Fig. 4.14: Multivapor with the crystal rack and the corresponding vacuum cover

The samples are sealed with the vacuum cover ① via the adapters ②. The cover serves as vacuum manifold collecting the vapor from each sample individually in grooved channels. This reduces the chance of cross-contamination significantly. A descending drain is connected to the condenser assembly by means of a ribbed PFA vacuum tube.

4.10 Protective shield (optional)



Fig. 4.15: Protective shield

The protective shield protects the user from splashes of hot medium and debris from the sample tubes in the case of implosion or explosion.

4.11 Condensation (optional)



Fig. 4.16: Type C (left) and type S (right) condenser assemblies

There are two types of condensers available. Type C condensers (left) are used with dry-ice/acetone and type S condensers (right) are connected to tap water or a recirculating chiller. Both are equipped with a P+G coating to provide maximum safety. The receiving flask is available in 1 or 2 L capacity. Alternatively, an insulated refrigerated receiver with an internal cooling coil can be used in combination with a type S condenser. This allows evaporation of solvent mixtures with different boiling points without interruption between fractions.

4.12 High-boiling solvents - Woulff bottle (optional)



Fig. 4.17: Woulff bottle installed

To prevent boiling retardation and for high-boiling solvents which tend to condense in the vacuum tube as well as for solvents which tend to foam an optional solvent reservoir – the so-called Woulff bottle – can be fixed at the rear of the instrument. The vapor is then first transferred from the cover to the bottle and then further to the condenser assembly.

4.13 Vacuum solution (optional)



Fig. 4.18: Recommended vacuum solution for use with the Multivapor

Evaporation under vacuum is performed by means of a vacuum pump. With the V-700 PTFE diaphragm pump an ultimate vacuum of less than 10 mbar is achieved, which is more than sufficient for most applications. Sophisticated vacuum control is gained using the V-850 or V-855 controller. The latter includes gradient functions, solvent libraries and automatic vacuum control algorithms.

4.14 Connection to a rotary evaporator (optional)



Fig. 4.19: A resource-sharing combination of the condenser, the vacuum pump and the controller with both the Rotavapor and the Multivapor

In addition to the stand-alone unit, the Multivapor can be used in combination with a rotary evaporator. The vapor is then first transferred to the condenser assembly of the Rotavapor with the help of the T-piece. The vacuum is generated by the vacuum pump and regulated by the controller. The glass T-piece used for this setup is compatible with all BUCHI products and the major manufacturers of rotary evaporators. The prerequisite for a compatibility is the presence of an S35 spherical joint between the condenser and the receiving flask.

4.15 Refrigerated receiver (optional)



Fig. 4.20: Cooled receiver with type S condenser

The refrigerated receiver keeps the solvent at a low temperature throughout the run. It is essentially a horizontal cylindrical receiving flask with an insulation jacket and an internal cooling loop. The cooling loop is connected to a recirculating chiller and keeps its content at a low temperature. A curved U-tube serves as a level indicator and allows the flask to be emptied without disconnection. The total volume of the flask is 2.5 L.

5 Putting into operation

This chapter describes the installation of the Multivapor and gives instructions on initial start-up.

NOTE

Inspect the instrument for damages during unpacking. If necessary, prepare a status report immediately to inform the postal company, railway company or transport company. Keep the original packaging for future transport.

5.1 Installation site

Place the instrument on a stable, horizontal surface and consider the maximum product dimensions.

NOTE

The shaking platform moves horizontally in an orbital manner with up to 485 rpm (for the P-12) which may lead to considerable shaking of the surface. For this reason ensure that the surface is stable.

It is not necessary to place the instrument in a fume hood, however, the exhaust gas from the vacuum pump should be directed toward a fume hood.

5.2 Electrical connections

	NOTICE
	<p>Risk of instrument damage by wrong mains supply.</p> <ul style="list-style-type: none"> • External mains supply must meet the voltage given on the type plate • Check for sufficient grounding

5.3 Commissioning the Multivapor basic instrument

5.3.1 Commissioning the crystal rack

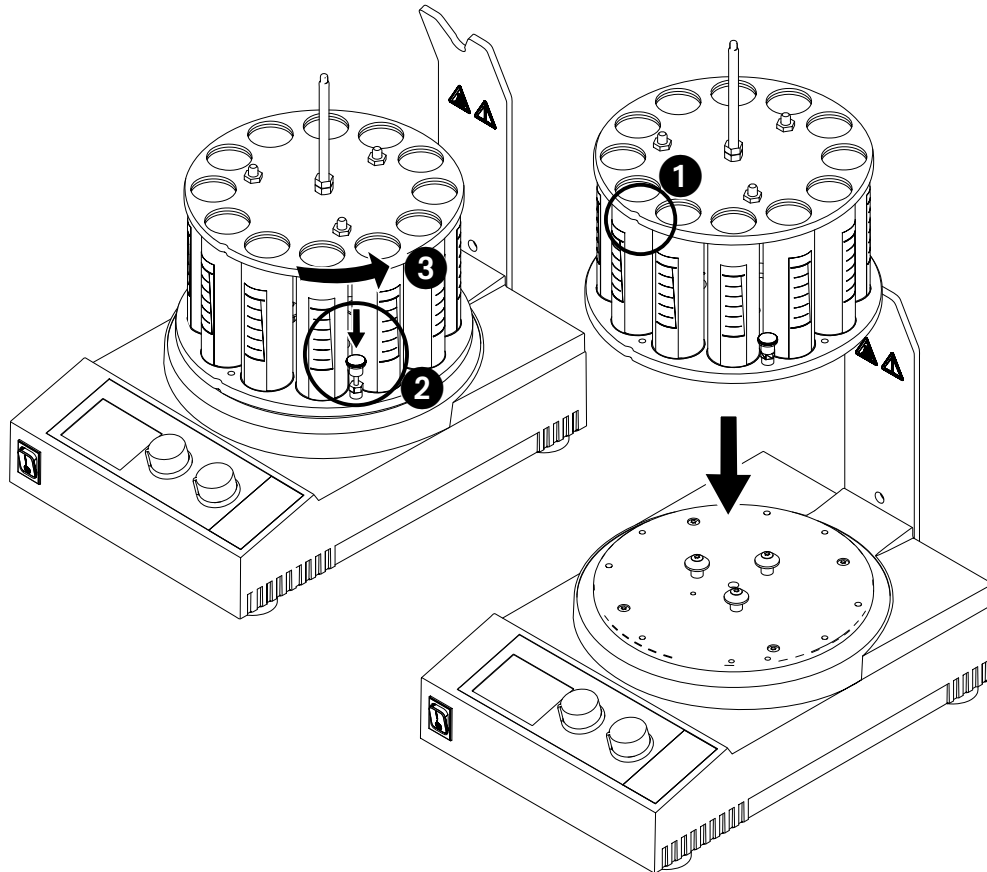

Fig. 5.21: Installation of the crystal rack onto the heating plate

Remove any particles from the heating plate and the bottom side of the crystal rack. Place the rack onto the heating plate with the indentation to the front.

Put the rack back on the instrument - the three pins have to be aligned with the openings in the bottom of the rack and the notches **1** on the rack have to point to the front side (a little left from the middle) of the instrument.

Pull and hold the locking device **2**.

Turn the rack a little counter clockwise and let the locking device go **3**.

Turn the rack further counter clockwise, until the locking device snaps into place.

Optionally you can fix the the rack with the supplied four screws **2**.

Check the rack for a tight mounting!

5.3.2 Assembling the Woulff bottle (optional)

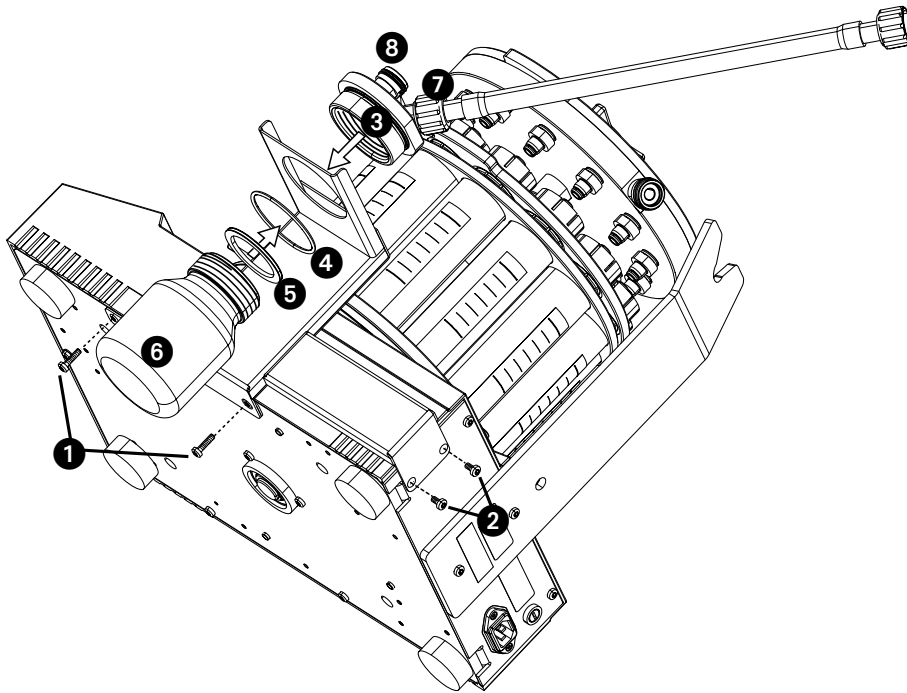
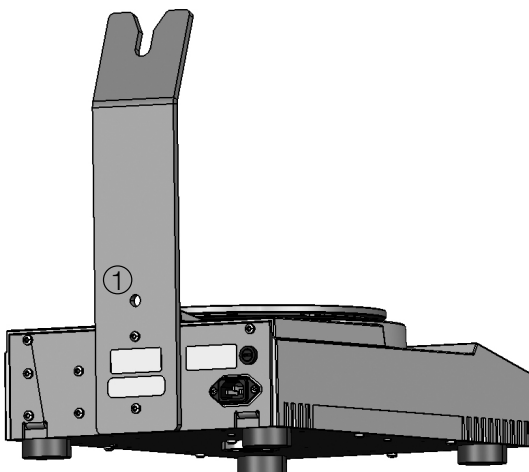

Fig. 5.22: Assembling the Woulff bottle

- ① Fix the Woulff bottle holder on the bottom of the instrument by replacing the existing screws with the provided longer screws.
- ② Fix the Woulff bottle holder on the rear side of the instrument by replacing the existing screws with the provided longer screws.
- ③ Add the cover of the Woulff bottle from above to the holder.
- ④ Fix the cover from below on the holder with the provided O-ring.
- ⑤ Place the gasket from below into the cover.
- ⑥ Screw the bottle into the holder.
- ⑦ Connect the delivered tube on the left angled connector of the cover.
- ⑧ Connect the tube from the condenser to the Woulff bottle on the right straight connector (not connected in the figure).

5.3.3 Anti-seismic tie-down



- ① Hole to fix the instrument in earthquake-susceptible regions.

Fig. 5.23: Anti-seismic tie-down

5.4 Glass assembly

	<p style="text-align: center;">NOTICE</p> <p>Risk of glass breakage by excessive strains.</p> <ul style="list-style-type: none"> • Mount all glassware parts without strains • Check glassware for proper fixing regularly and readjust fixing points if necessary • Do not use defective glassware • Use the protective shield (optional)
---	---

5.4.1 Type S and type C condenser

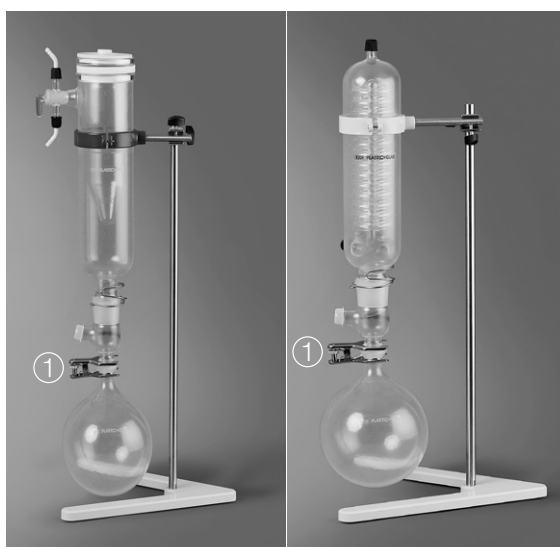

Fig. 5.24: Installation of the condenser assembly on the support

Install the condenser assemblies on the provided support or on a stable laboratory rod ensuring that the stand base is oriented in the direction of the condenser. Secure the receiving flask with the clip ① provided for this purpose.

5.4.2 Condenser assembly with the refrigerated receiver (optional)

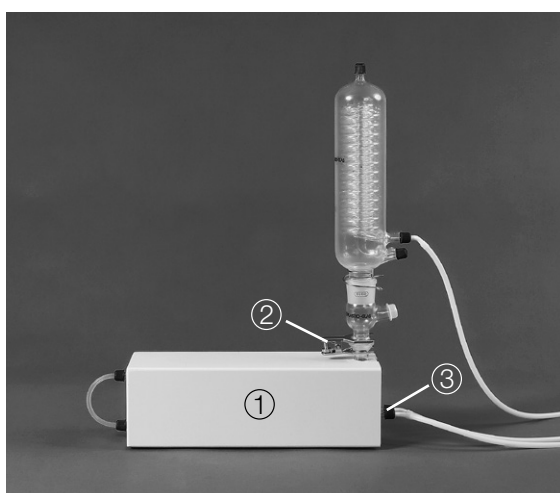

Fig. 5.25: Type S condenser with the refrigerated receiver

The refrigerated receiver ① can be used as an alternative to the receiving flask and is secured using the clip ②. The internal cooling loop is connected to a cooling source ③ (tap water or recirculating chiller).

5.5 Tube connections

5.5.1 Cooling water

When connecting the white cooling water tubes (silicon), consider the following:

- Use GL14 tube clips.
- The tubes used must all have the same inner diameter (approximately 6 mm).
- For safety reasons, secure the tubes with commercial tube pivoting clamps or cable binders.
- To save cooling water and/or reduce the temperature of the coolant, a recirculating chiller like the F-100 / F-108 is recommended.
- Check the tubes from time to time and replace them if they become brittle.

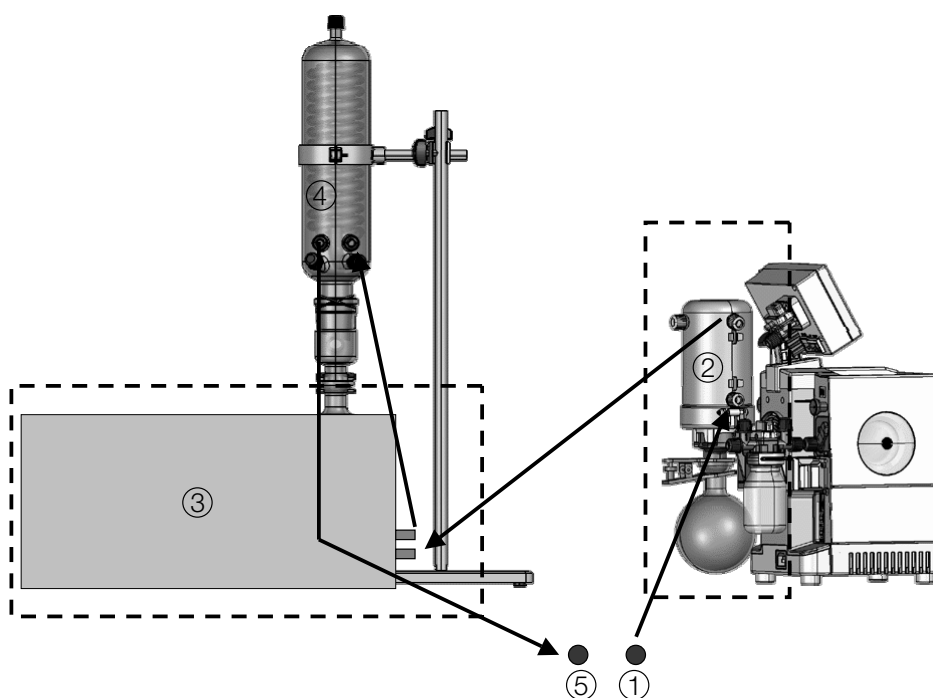

- | | |
|------------------------------------|---------------------|
| ① Coolant in | ④ Primary condenser |
| ② Secondary condenser (optional) | ⑤ Coolant out |
| ③ Refrigerated receiver (optional) | |

Fig. 5.26: Liquid flow direction for primary condenser and post-pump secondary condenser

NOTE

It is important to connect the coolant with the secondary condenser first and then with the primary condenser as the temperature rise in the coolant primarily takes place in the latter.

When the type C condenser is used no tube connections for cooling are required.

5.5.2 Vacuum tubes

When establishing the vacuum tube (red rubber) connections proceed as follows:

- Use GL14 tube clips.
- The tubes used must all have the same inner diameter (approximately 5 mm).
- Keep vacuum tubes as short as possible.
- When operating with the Vacuum Controller V-850 / V-855 and the Vacuum Pump V-700 / V-710 connect a Woulff bottle between the vacuum source and the Multivapor.
- When operating with a pump other than a V-700 / V-710, connect a valve unit to the V-850 / V-855 to control the vacuum.
- Tubes do not need to be secured.
- Check the tubes from time to time and replace them if they become brittle.

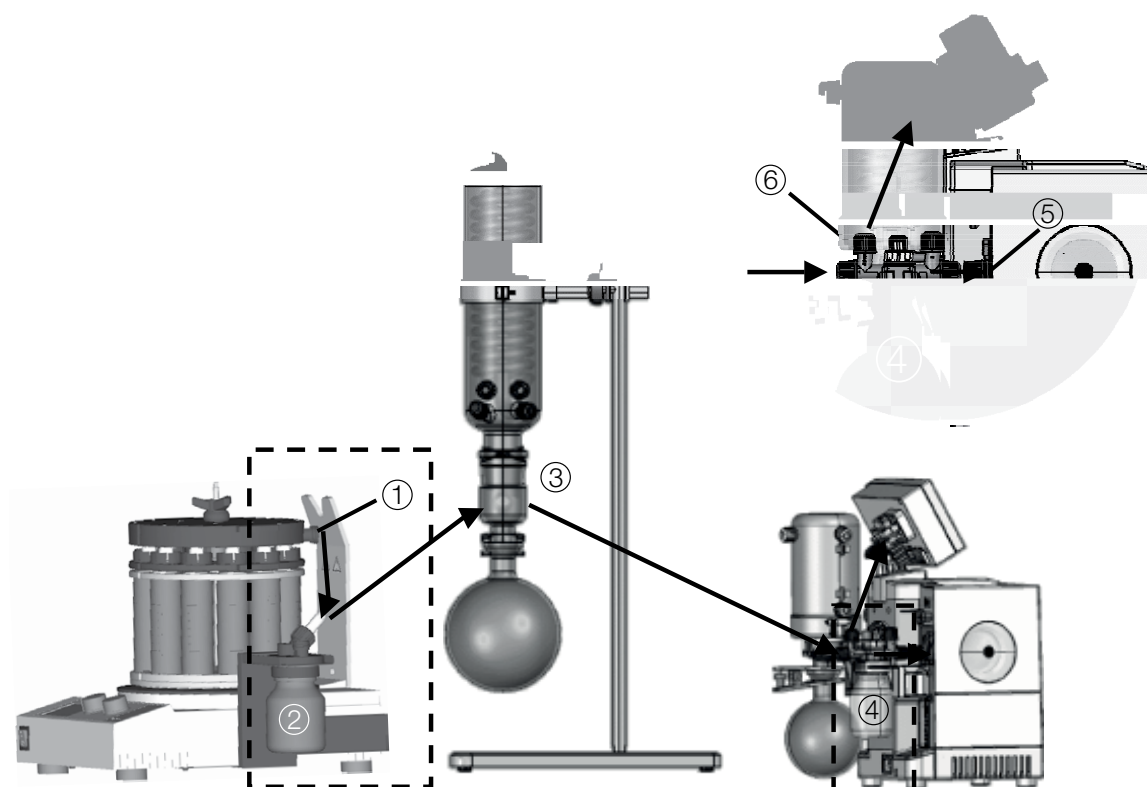

① Vacuum cover out

② Woulff bottle at Multivapor (optional)

③ Condenser vacuum joint

④ Woulff bottle at vacuum pump (optional)

⑤ Woulff bottle connection to vacuum pump

⑥ Woulff bottle connection to vacuum controller

Fig. 5.27: Standard vacuum connections with condenser and V-700 / V-855 vacuum solution

5.6 Commissioning the Multivapor-Rotavapor edition



The T-piece is inserted between the condenser and the receiving flask of the rotary evaporator and fixed with the clip. The vacuum tube is connected to the SVL 22 joint of the T-piece.

Fig. 5.28: Commissioning the Multivapor-Rotavapor edition

NOTE

As the system has to be closed in order to generate a vacuum, the vapor duct on the rotary evaporator must be sealed with an empty flask during operation.

5.7 Functional test

Once all of described installation steps have been completed proceed with the following functional test to correctly operate the instrument.

5.7.1 Vacuum tightness test

NOTE

The vacuum tightness test can only be carried out with a vacuum controller installed or when a pressure measuring device (manometer) is installed between the pump and the Multivapor.

1. Start the instrument and adjust the desired rotational speed, e.g. position 8.
2. Apply a vacuum of a preset value, e.g. 100 mbar.
3. Stop the vacuum and measure the pressure increase Δp within 2 min.
4. The instrument is tight if $\Delta p < 10$ mbar within 2 min.

To tighten the instrument, proceed as follows:

1. Close the vacuum tube from the vacuum pump to the condenser and check the leak rate of the pump. In case of a leak consult the operation manual of the vacuum pump.
2. Close the vacuum tube at the vacuum tube side of the condenser with a blind cap and check the leak rate of the condenser assembly. In case of a leak check the seals of the vacuum tube and the GL-14 caps. Grease the glass joints if necessary.
3. Close the conical adapters of the vacuum cover using the blank adapters. In case of a leak exchange the seals of the ribbed vacuum tube and/or the O-rings at the conical adapters. In case of chemically affected O-rings, change the material of the O-rings according to Table 3-5.
4. Verify the quality of the sample tubes. They must not be chipped.
5. Check if the seals for the tube adapters are sound and correctly placed. In case of a leak exchange

the corresponding seals. The adapter seals have to be exchanged regularly. The corresponding spare parts are listed in section 10.3.

NOTE

Overtightening the lock nuts on the conical adapters of the vacuum cover and sample tubes will scarcely remedy a leak problem, but would decrease the lifetime of the parts. The problem is more readily solved by checking the quality of the corresponding seals, i.e. the adapter seals and/or the conical O-rings.

	NOTICE
	<p>Risk of thread damage by overtightening</p> <ul style="list-style-type: none">• Do not use a wrench with a long lever arm when exchanging the conical adapters due to physical or chemical damage

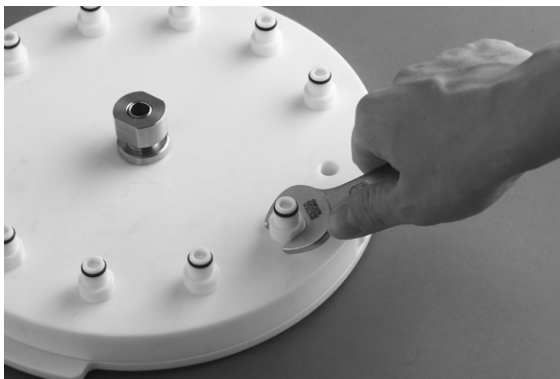





Fig. 5.29: Tightening the lock nuts on the conical adapters

6 Operation

This chapter explains the operating elements and possible operating modes. It gives instructions on how to operate the Multivapor properly and safely.

6.1 Settings at the Multivapor platform

Variable parameters of the instrument are the temperature and rotational speed of the horizontal movement of the heating plate.

	<p style="text-align: center;">NOTICE</p> <p>Risk of glass breakage by excessive strains.</p> <ul style="list-style-type: none"> • Mount all glassware parts without strains. • Check glassware for proper fixing regularly and readjust fixing points if necessary • Do not use defective glassware. • Use the protective shield (optional).
	<p style="text-align: center;">NOTICE</p> <p>Risk of instrument damage by lack of heating medium in the crystal rack.</p> <ul style="list-style-type: none"> • Make sure that there is always heating medium within the crystal rack when the instrument is switched on and the actual temperature is below the set temperature.
	<p style="text-align: center;">CAUTION</p> <p>Risk of minor or moderate burns when handling hot parts.</p> <ul style="list-style-type: none"> • Do not touch hot parts or surfaces (especially the heating plate with up to 95 °C). • Make sure that no liquid can overflow from the glass cylinders when the samples tubes are submerged. • Use the protective shield (optional) to shield hot parts.

NOTE

The display specifies the temperature of the water in the glass cylinder. During evaporation heat is transferred from the heating medium to the condenser eventually, which may result in a considerable temperature drop of up to 15 °C in the water bath. This fact has to be taken into account when selecting an appropriate coolant temperature inside the condenser.

6.1.1 Selecting a preset temperature

A preset temperature setting ensures that the heating bath temperature cannot be changed either accidentally or deliberately during the evaporation process.

To switch to the preset mode, proceed as follows:

- Switch off the instrument.
- Turn the adjusting knob to the 95 °C (max) position.
- Switch on the instrument. The set temperature setting flashes on the display.
- Turn the knob to the desired set temperature, e.g. 60 °C within 10 seconds and wait until the set temperature setting stops flashing.
- This set temperature is now retained whenever the heating bath is switched on and cannot be changed with the adjusting knob anymore.

6.1.2 Changing/switching off the preset temperature

To change or switch off the preset temperature, proceed as follows:

- Switch off the instrument.
- Turn the adjusting knob to the 0 °C (min) position.
- Switch on the instrument. The preset temperature setting is now deleted and the temperature can be selected via the knob again.

6.1.3 Setting the rotational speed

	CAUTION
<p>Risk of minor or moderate injuries due to wrong rotation speed adjustment!</p> <ul style="list-style-type: none"> • Do not exceed 370 rpm if using the P-12 platform with the P-6 configuration. Otherwise strong vibration will damage the P-12 and glass cylinders. 	

NOTE

As soon as the power plug is connected and the main switch is turned on, the platform moves horizontally in an orbital manner according to the setting adjusted at the corresponding knob.

The rotational speed of the moving platform ranges from 0 to 370 rpm for the Multivapor P-6 and from 0 to 485 rpm for the Multivapor P-12. Within this range even fairly viscous samples are thoroughly agitated by strong vortex action. For most applications a constant rotational speed at position 8 is sufficient.

The absolute value of the rotational speed is not displayed. The indication 0...10 on the platform is linearly increasing from 0 corresponding to 0 rpm to 10 corresponding to 370 rpm or 485 rpm, respectively.

NOTE

Once optimized, the vortex action remains constant throughout the evaporation process, given that the shape and inner diameter of the sample tubes is constant. Changing glassware geometries, e.g. to conical bottoms (the so-called Falcon tubes) or rounded tubes, may alter the efficiency of agitation which may result in boiling retardation. It is therefore advisable to adjust the rotational speed during the process.

6.2 Sample preparation

6.2.1 Heating up the instrument



Distilled water is added to each glass cylinder on the crystal rack to transfer the heat from the heating plate to the sample tube. Equal amounts of water must be added to each cylinder to provide a uniform heat transfer. A level indication designates the optimum volumes depending on the type of sample tube.

Turn on the heating as soon as each position is filled. It takes approximately 20 min to equilibrate the system, i.e. until the water temperature remains constant.

Fig. 6.30: Filling distilled water to a level where strong agitation during operation is obtained

NOTE

- *The water volume is the decisive parameter for optimal heat transfer, therefore it is not advisable to add too much water. Heat transferred into the sample decreases with an increasing volume. This is mainly the result of insufficient mixing of the heating medium. Therefore, fill in only as much water so that the sample vessel dips into the heating medium by 2 to 3 cm. Optimize the rotation to obtain a vigorous vortex for both the sample and the heating medium.*
- *To reach equilibrium turn on the instrument and set it to the desired evaporation temperature 20 min prior to the distillation process.*

6.2.2 Sample preparation

NOTICE	
	<p>Risk of lifetime shortening of the adapter seals and the quick lock nut.</p> <ul style="list-style-type: none"> • Fix all connections only hand tight. • Avoid overtightening.

The installation and sealing of the sample tube is carried out as follows:

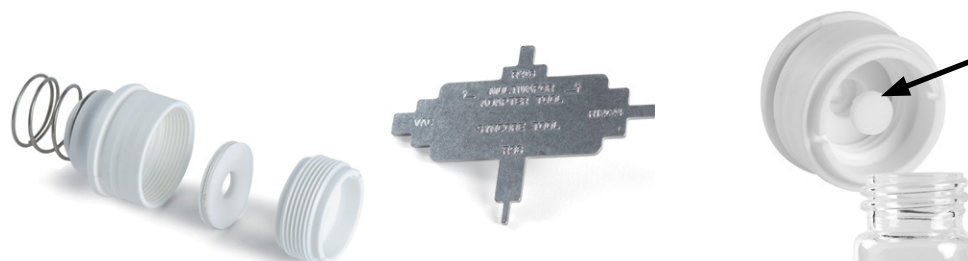

- Use the Multivapor tool for removing the insert of the adapter and for changing the gasket.
- Use the optional PE frits for foam and splash protection.
- To remove the optional PE frits from the tube adapter, push a thin object from the top through the hole.



- Screw the adapter onto the tube.



- Place the sample tube into the transfer plate. Make sure that it snaps in place.



- Occupy all positions or use the blank adapters instead (optional).



- Transfer the whole assembly at once into the pre-heated crystal-rack.

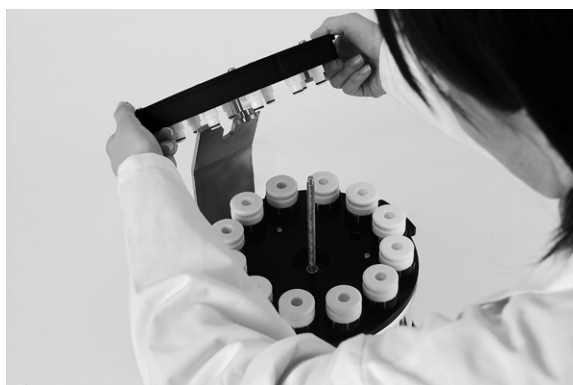

- Close the vacuum cover.



- Tighten the vacuum cover using the quick lock.

Fig. 6.31: Sample preparation

6.3 Selecting the distillation conditions

To achieve optimal distillation conditions, the distillation energy supplied by the heating platform must be removed by the condenser. To ensure this, operate the instrument according to the following general rule:

Heating medium: 55 °C \longleftrightarrow 25 °C Vapor: 30 °C \longleftrightarrow 20 °C Coolant: max. 10 °C

How are these conditions achieved?

- Set the temperature of the instrument to 55 °C.
- Use a recirculating chiller to set the temperature of the coolant to max. 10 °C or use a dry-ice condenser (type C) alternatively.
- The coolant flow is adjusted to approx. 600 – 800 mL/min.
- Define the operating vacuum according to the boiling point of the solvent which in this particular example is 30 °C. The corresponding pressure can be deduced from the enclosed Solvent Table or from the Solvent Library implemented in the Vacuum Controller V-850 / V-855.

This rule can be extrapolated to higher temperatures, e.g. according to the following example:

Heating plate: 75 °C \longleftrightarrow 25 °C Vapor: 50 °C \longleftrightarrow 20 °C Coolant: max. 30 °C

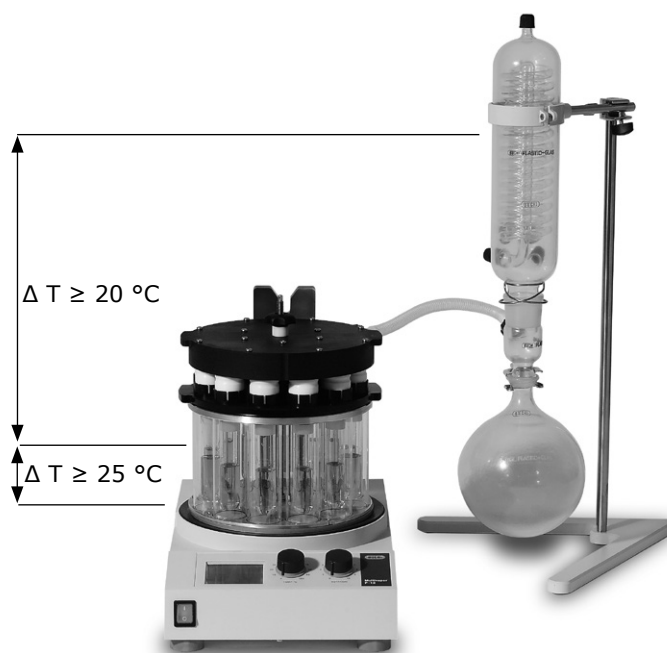

Fig. 6.32: Schematic depiction of the relative temperature drop within the distillation setup

NOTE

The 25/20 °C rule indicates that during operation the displayed temperature does not correspond to the temperature of either the vapor or the sample mixture. During distillation there is a temperature drop relative to the display of approx. 10 °C for the sample and approx. 25 °C for the vapor.

The distillation conditions of the Multivapor are therefore not directly comparable to that of the Rotavapor as the heat transfer in the latter, from heating bath to sample flask, is more efficient compared to that observed in the Multivapor. At identical set temperatures, the actual temperature of the Multivapor sample would be approx. 15 °C less than the Rotavapor sample.

6.4 Distillation

Before operating the system, the following conditions must be fulfilled:

- All electrical connections are established correctly.
- All vacuum and coolant connections are established correctly. The latter being secured with cable binders.
- All seals are inserted correctly.
- Water is filled in according to the level indication.

To start operating the system proceed as follows:

- Switch on the instrument.
- Set the temperature (recommended: 50 – 80 °C).
- Adjust the coolant flow (recommended: 5 – 20 °C, 600 – 800 mL/min).
- As soon as the instrument is equilibrated (after approx. 20 min), place the sample tubes into the crystal rack. Use empty sample tubes or blank adapters (optional) to occupy vacant positions.
- Close the vacuum cover and screw it hand tight.
- Set the rotational speed (recommended: pos. 8 - 10).
- Turn on the vacuum pump and controller.
- Set the vacuum according to the 25/20 °C rule.
- Wait approx. 5 min after the vacuum has reached the set point. The temperature of the sample may, depending on the set temperature, drop during initial evaporation, resulting in a slight subsequent readjustment of the vacuum conditions.
- If the distillation does not start, carefully reduce the vacuum gradually or increase the temperature at the instrument. Check the efficiency of the condenser and make sure that the vapor is not directly sucked into the pump.

NOTE

In general the smaller the test tubes the higher the risk of boiling retardation. In order to prevent contamination of the vacuum cover apply a pressure gradient to reduce the pressure gradually (see chapter 6.5.2) and/or use the optional PE frits as splash and foam protection.

6.5 Optimizing the vacuum conditions (optional)

There are three distinct ways to evaporate multiple samples in parallel with the Multivapor using either the Vacuum Controller V-850 or V-855. The main functions are described briefly in the following sections. For further information please consult the corresponding Operation Manual.

6.5.1 Manual vacuum control and solvent library (V-850 / V-855)

Choose the temperature according to the 25/20 °C rule. The corresponding pressure is best derived from the Solvent Library. This is achieved as follows:

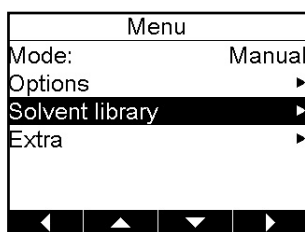

- Open the Solvent Library.

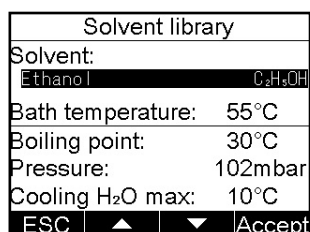

- Select the corresponding solvent.

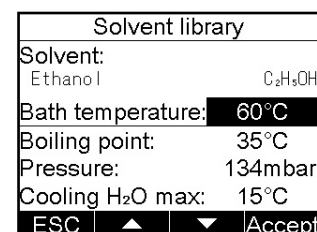

- Set the instrument temperature.

6.5.2 Pressure gradients (V-855)

Setting the pressure manually to the boiling point involves the risk of boiling retardation. To minimize this risk, it is strongly recommended to program a pressure gradient that slowly converges to the optimized ultimate vacuum. This is achieved as follows:

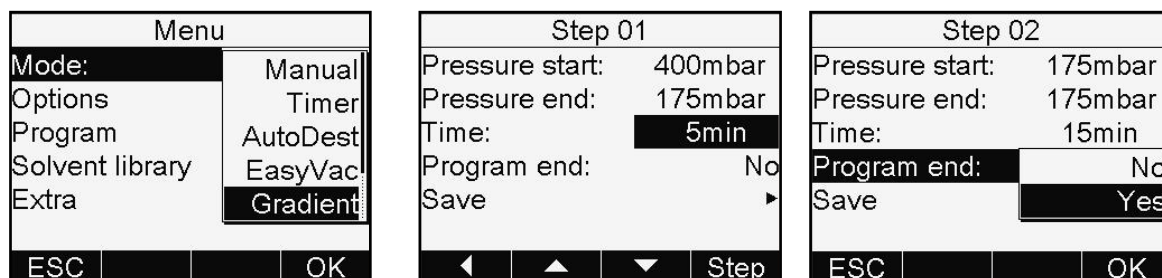

- Select the Gradient mode.
- Program the first step.
- Program additional steps and terminate the programming by selecting "Yes".

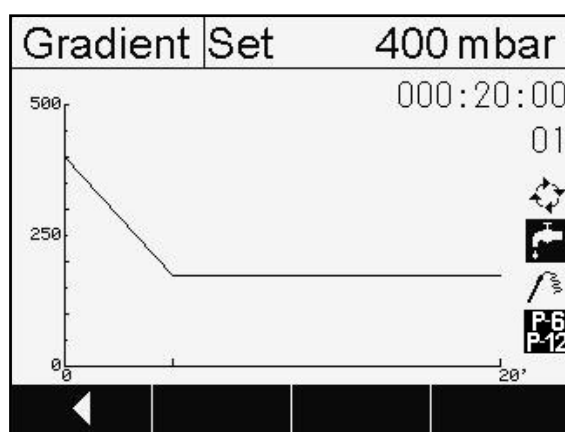

Fig. 6.33: Pressure gradient for distillation of ethanol at 65 °C (instrument setting)

The corresponding gradient can be stored for future recall and displayed at any time. For further information please consult the operation manual of the vacuum controller.

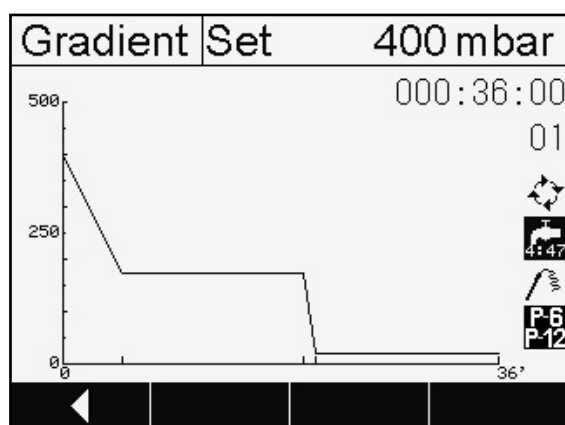

Fig. 6.34: Example of a gradient setting with a drying step subsequent to the solvent evaporation

It is often desirable to dry any remaining solid sample immediately after solvent evaporation. For routine procedures it is advisable to implement this step directly into the gradient program. This reduces the amount of instrument handling and keeps supervision to a minimum.

NOTE

A direct drying step without interruption of the distillation process is only possible if the distilled solvent is kept at low temperature, i.e. below the corresponding boiling point of the ultimate vacuum setting. This is achieved by using an ice bath or the optional refrigerated receiver in combination with a recirculating chiller.

Pressure gradients are also an ideal tool for complex mixtures with low-boiling components which

tend to foam or splash. A preceding terrace at high pressure for approx. 10 min usually significantly reduces the risk of splashing or foaming.

6.5.3 Automatic distillation (V-855)

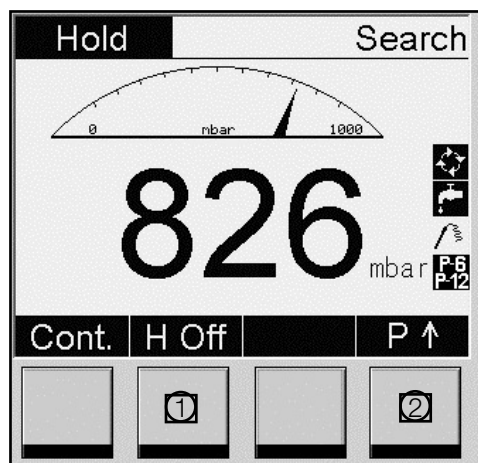

Fig. 6.35: Automatic distillation

The method of choice to evaporate even complex sample mixtures automatically is the EasyVac mode, implemented in the Vacuum Controller V-855. The EasyVac algorithm is based on relative pressure changes over time and therefore requires no additional accessory for operation.

It is possible to interrupt the algorithm at any time by pressing the P↑ button ② and resuming the automatic process by pressing the H Off button ①. This is a very helpful measure to reduce foaming and splashing for delicate mixtures.

NOTE

A tight system, i.e. $\Delta p < 5$ mbar per minute, is an essential prerequisite for the proper operation of EasyVac.

6.6 Optimizing the distillation conditions

Depending on the distilled solvent optimization of the parameters during the process is sometimes required. An optimal loading of the condenser is approx. $\frac{1}{2}$ of its height.

To achieve this either

- reduce the pressure or
- increase the temperature

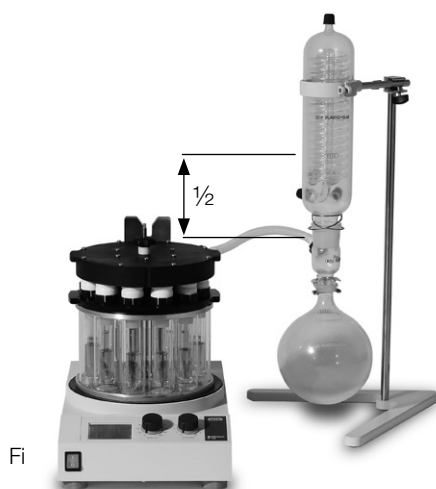

NOTE

In case of a temperature rise only a fraction of the additional energy is used for distillation. The majority is discharged into the environment due to the increasing temperature difference of the

heating plate and the ambient temperature.

6.7 When the distillation “dies out”

When the distillation “dies out”, i.e. the process draws to a close, back evaporation may occur. In this event appropriate actions are either to interrupt the distillation in order to empty the receiving flask or to keep the solvent at a low temperature (see also section 6.5.2).

A convenient accessory for the latter is the refrigerated receiver.

The solvent can be disposed of by opening the top GL14 tube connection and subsequently draining the solvent into a beaker.

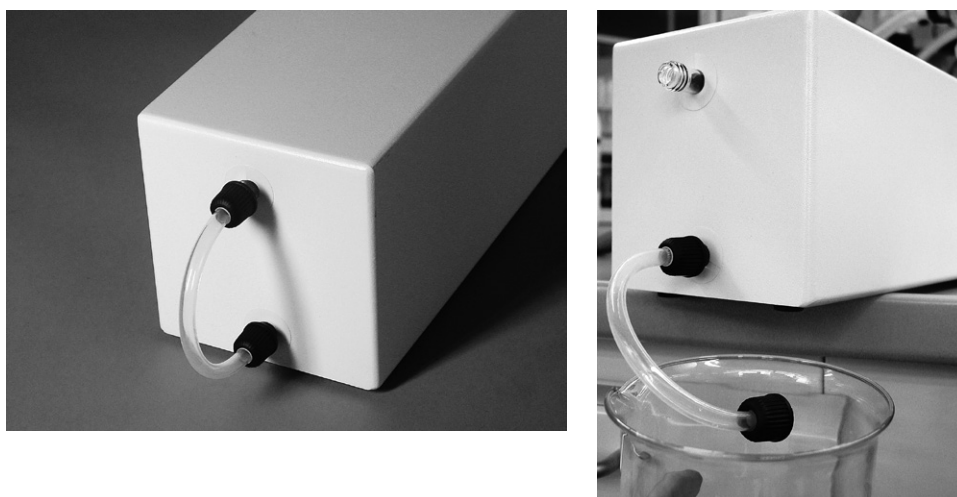

Fig. 6.37: Drainage of the cooled receiving flask

6.8 At the end of a run



Fig. 6.38: Holder for the vacuum cover

When the distillation is complete the system is aerated and the rotation is stopped.



By the time the quick lock nut is opened, the retaining springs (not shown in the picture) pull the vacuum cover and the tube adapters apart, facilitating the opening of the cover. However, the instrument can also be operated without the retaining springs.

Put the vacuum cover to its holder and transfer the samples back to the sample preparation rack. Thus, the time during which the samples are exposed to a warm environment is reduced.



If there is no intention to perform another distillation, turn off the instrument and the coolant supply to save energy and resources.

7 Maintenance

This chapter provides instructions on all required maintenance to keep the instrument in good working condition.

 	WARNING
	<p>Death or serious burns by electric current at cleaning.</p> <ul style="list-style-type: none"> • Switch off the instrument • Disconnect the power cord and prevent unintentional restart • Wait until the instrument is completely dry before reconnecting to mains

7.1 Housing

 	NOTICE
	<p>Risk of instrument damage by using solvents as cleaning agents.</p> <ul style="list-style-type: none"> • Use a moist cloth and mild soap to clean the instrument.

Check the housing for defects (controls, plugs) and clean it regularly with a moist cloth.

7.2 Tube connections and joints

Visually examine the tube connections regularly, if tubes become cracked and brittle replace them with new ones.

Grease all joints at the condenser side regularly to achieve an optimum sealing of the system.

7.3 Sealing system

	NOTICE
	<p>Risk of seal damage by improper handling.</p> <ul style="list-style-type: none"> • Never apply grease. • Never touch the seals with sharp objects.

Clean the seals regularly and visually examine them at this occasion. If seals become cracked and brittle replace them with new ones.

7.3.1 Cleaning the seals

To prolong the lifetime of the seals, rinse them routinely with water or ethanol and always in case of unwanted sample contamination (foaming or boiling retardation). Dry the cleaned seals with a soft cloth.

7.3.2 Replacing the tube adapter seals



Fig. 7.39: Replacing the tube adapter seals

- ① Use the Multivapor tool for removing the insert of the adapter and for changing the gasket.
- ② Replace the gasket if damaged or broken, and reassemble.

7.3.3 Replacing the conical adapter O-rings

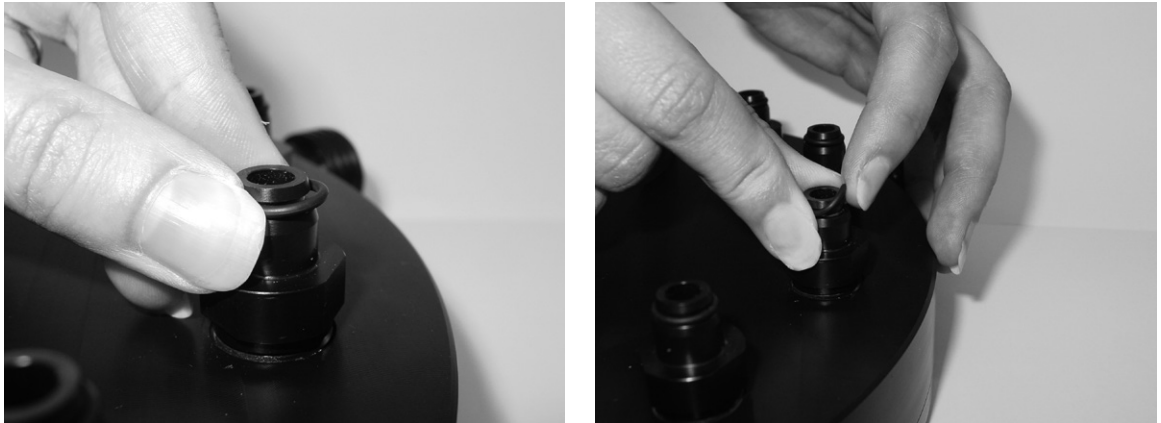

Fig. 7.40: Replacing the conical adapter O-rings

The O-ring of the conical adapters may become either chemically or physically damaged under harsh conditions or upon intensive regular use respectively.

The vacuum cover is equipped with EPDM O-rings. A set of 12 FKM O-rings is enclosed. A list of recommended applications and restrictions depending on the material is given in Table 3-8.

Alternatively, for very harsh conditions FFKM O-rings are available (see also chapter 10.2), which are provided on the PEEK vacuum cover.

In order to remove the O-rings push with one hand horizontally and with the other vertically to the top.

7.3.4 Cleaning the vacuum cover and replacing the corresponding O-rings

NOTICE	
	<p>Risk of component damage.</p> <ul style="list-style-type: none"> • Close the screws at the vacuum cover hand-tight. • Avoid overtightening.

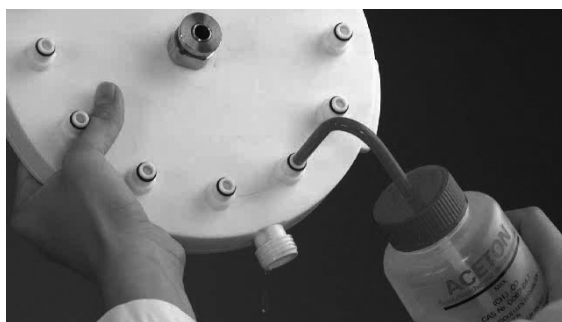

Fig. 7.41: Cleaning the vacuum cover

Clean the vacuum cover regularly by rinsing it with water or ethanol through the holes of the conical adapters.

Unmount the cover only in case of severe contamination. Use the optional PE frits to protect the cover from any possible splashes (see also chapter 4.6).

7.4 Crystal rack

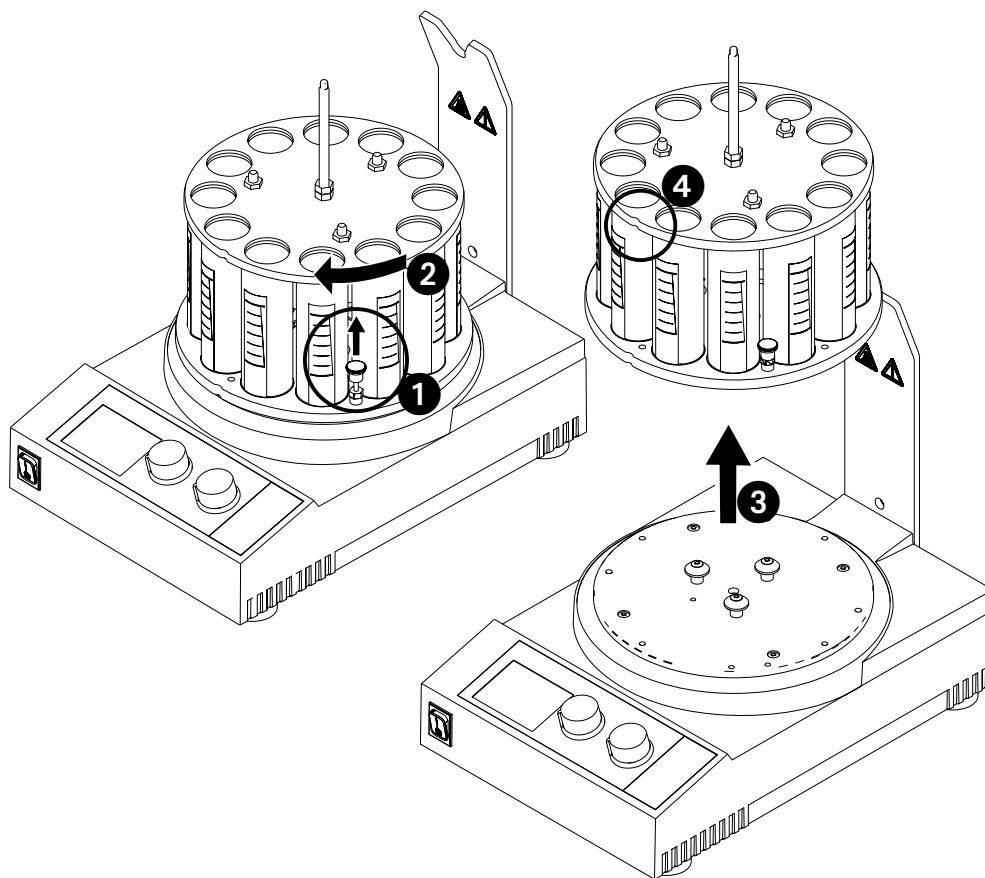

Fig. 7.42: Removing the crystal rack for cleaning

To remove the crystal rack for cleaning, proceed as follows:

- ❶ Pull and hold the locking device.
- ❷ Turn the rack a little clockwise and let the locking device go. Turn the rack further clockwise, until the locking device snaps into place.
- ❸ The rack can now be taken away from the instrument.

To reinstall the rack proceed in reverse order:

Put the rack back on the instrument - the three pins have to be aligned with the openings in the bottom of the rack and the notches ❹ on the rack have to point to the front side (a little left from the middle) of the instrument.

Pull and hold the locking device.

Turn the rack a little counter clockwise and let the locking device go.

Turn the rack further counter clockwise, until the locking device snaps into place.

Check the rack for a tight mounting!

To clean the crystal rack remove it from the platform and drain it with water.

In case of glass breakage or severe contamination, disassemble the crystal rack as follows:

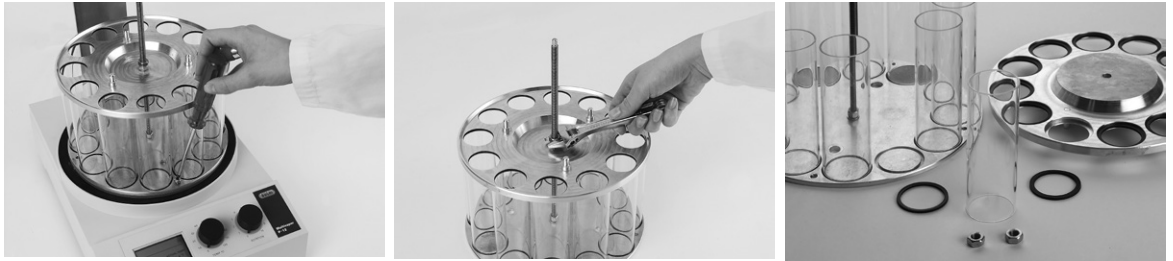

- If the rack is screwed to the platform, remove the four screws at the bottom. Remove the rack and empty it.
- If necessary, unscrew the top screw nuts and remove the lid.
- Disassemble the whole rack.

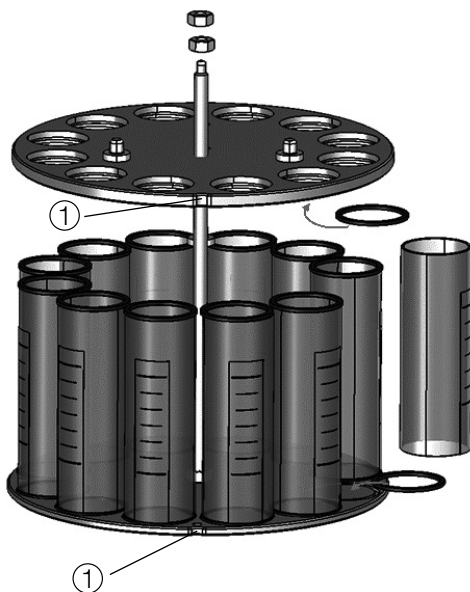

Fig. 7.43: Reassembling the crystal rack

In most cases the removal and cleaning of the whole assembly is sufficient, only disassemble the rack in the event of glass breakage or severe contamination. To reassemble the crystal rack, place the flat seal into the grooved rings of both the rack base and the lid. Place the glass cylinders onto the seals and close them with the lid according to Fig. 7.43. Make sure that the indentation ❶ of the bottom and top plate is oriented in one line.

NOTE

Screw the lid only hand-tight as overtightening may break the glass cylinders. Test the tightness of the system with water prior to the installation onto the heating plate.

7.5 Glass components

To prolong the lifetime of the glass components rinse them regularly with water and a commercial cleaning agent (e.g. mild soap solution).

NOTE

It is recommended to clean all glass components manually. Use an alkaline cleaner to remove dirt, e.g. algae adhering to the condenser coil.

When a thin copper wire is introduced into the condenser coil, the risk of dirt adhering to the condenser coil is reduced.

Remove all grease from the joints. After cleaning and completely drying each glassware component, visually inspect them for glass splinters or tears. As these components are under vacuum during operation they are subject to strain.

Regularly check the glassware components for damage and use only glassware in perfect condition, i.e. glassware without cracks or stars.

Chipped sample tube borders may cause leaking. Check the quality of the sample tubes regularly, especially when a dishwasher is used.

7.6 PE frits (optional)

To remove the optional PE frits from the tube adapter, push a thin object from the top through the hole.

Fig. 7.44: Removing the PE frits

8 Troubleshooting

The following chapter describes how to resume operation of the instrument in the event of any minor problem. It will list some possible occurrences, their probable cause and suggests how to remedy the problem. The troubleshooting table below lists possible malfunctions and errors of the instrument and describes operator enabled courses of action to correct some of those problems by him or herself. The appropriate course of action is listed in the column “Corrective measure”. The elimination of more complicated malfunctions or errors is usually performed by a BUCHI technical engineer who has access to the official service manuals. In this case, please refer to your local BUCHI customer service agent.

8.1 Malfunctions and their remedy

Table 8-1: General malfunctions and their remedy		
Malfunction	Possible cause	Remedy
Instrument does not work	Main switch off	Switch on main switch
	Instrument is not connected to mains supply	Check mains connection
	Fuse defective	Replace the fuse. If this malfunction occurs again, contact the BUCHI customer service.
Instrument does not heat	Over-temperature protection was burned	Heating plate must be replaced. Contact the BUCHI customer service.
	Fuse defective	Replace the fuse. If this malfunction occurs again, contact the BUCHI customer service.
Temperature is not adjustable	Instrument is set to the preset temperature mode	Follow the instructions in chapter 6.1.1
Rotation is not smooth	Uneven and/or unstable surface or 6 position rack on a P-12 instrument	Adjust the height of the feet and/or change location. Do not use a 6 position rack with a P-12 instrument (see label on the front panel) with rotations higher than 8. Place the rack on a P-6 platform.
System leaks	See chapter 5.7.1	See chapter 5.7.1
Vacuum is not reached	System leaks	See chapter 5.7.1
	Back evaporation from the distillate	Empty the receiving flask or cool the distillate (e.g. with an ice bath or the refrigerated receiver)
	Vacuum pump is inefficient	Check the characteristics and leaking rate of the vacuum pump
Distillation “died out”	Solvent mixtures; initial overheating of the sample	Decrease the pressure until the distillation starts again or increase the temperature

Table 8-1: General malfunctions and their remedy

Malfunction	Possible cause	Remedy
Distillation stopped despite not being dried out completely	Back evaporation of the distillate (especially for solvent mixtures)	Empty the receiving flask and restart the distillation or cool the distillate
	Malfunction in distillation procedure which is not exactly defined (e.g. sudden cooling, heat flow too low, etc.)	Decrease the pressure manually until the distillation starts again

Table 8-2: Malfunctions with vacuum controller and vacuum pump and their remedy

Malfunction	Possible cause	Remedy
Frequent switching of valve or pump	System leaks	See chapter 5.7.1
	Vapor sucked into the pump	Increase the pressure according to the procedure described in chapter 6.6
	Chosen hysteresis is too small	Choose larger hysteresis (if end vacuum is higher than 700 mbar switch to automatic hysteresis)
Valve does not switch	Valve is dirty or the valve cable is disconnected	Check the cable connection. If this malfunction occurs again, contact the BUCHI customer service

Table 8-3: Error messages

Error number	Possible cause	Remedy
E01	Temperature sensor defective	Contact the BUCHI customer service
E02	Triac defective, excess temperature	Contact the BUCHI customer service
E70	Program error due to a software or an electrical error	Switch the instrument off and on again. If this error still occurs, contact the BUCHI customer service.

8.2 Customer service

Only authorised service personnel are allowed to perform repair work on the instrument. These persons have comprehensive technical training and knowledge of possible dangers which might arise from the instrument.

Contacts for official BUCHI customer service offices are given on the BUCHI website at: www.buchi.com. If malfunctions occur on your instrument or you have technical questions or application problems, please contact one of these offices.

The customer service offers the following:

- Spare part delivery
- Repairs
- Technical advice

9 Shutdown, storage, transport and disposal

This chapter instructs on how to shut down the instrument, how to pack it for storage or transport and specifies the storage and shipping conditions.

9.1 Storage and transport

Store the instrument at a dry place. Store and transport the instrument in its original packaging.

	! WARNING
	<p>Death or serious poisoning by contact or incorporation of harmful substances.</p> <ul style="list-style-type: none"> • Wear safety goggles • Wear safety gloves • Wear a laboratory coat • Flush the instrument and clean all accessories thoroughly to remove possibly dangerous substances • Do not clean dusty parts with compressed air • Store the instrument and its accessories at a dry place in its original packaging

9.2 Disposal

To dispose of the instrument in an environmentally friendly manner a list of materials is given in chapter 3, please ensure that the components are separated and recycled correctly. Please follow current regional and local laws concerning disposal.

NOTE

When returning the instrument to the manufacturer for repair work, please copy and complete the health and safety clearance form on the following page and enclose it with the instrument.

9.3 Health and safety clearance form

Declaration concerning safety, potential hazards and safe disposal of waste, e.g. used oil.

Safety and health of our staff, laws and regulations regarding the handling of dangerous goods, occupational health and safety regulations, safety at work laws and regulations regarding safe disposal of waste, e.g. waste oil, require that for all Rotavapors and other products this form must be sent to our office duly completed and signed before any equipment is repaired or dispatched to our premises.

Products will not be accepted for any procedure and handling and repair / DKD calibration will not start before we have received this declaration.

- a) Fax or post a **completed copy of this form** to us in advance. The declaration must arrive before the equipment. **Enclose a second, completed copy with the product.** If the product is contaminated you must notify the carrier (**GGVE, GGVS, RID, ADR**).
- b) Inevitably, the repair process will be delayed considerably, if this information is missing or this procedure is not obeyed. We hope for your understanding for these measures which are beyond our control and that you will assist us in expediting the repair procedure.
- c) **Make sure that you know all about the substances which have been in contact with the equipment and that all questions have been answered correctly and in detail.**

1. Product (Model):

5. Way of transport / carrier:

2. Serial No.:

.....
Day of dispatch to BÜCHI Labortechnik AG:
.....

3. List of substances in contact with the equipment or reaction products:

We declare that the following measures - where applicable - have been taken:

- The oil has been drained from the product.

3.1 Chemical/substance name, chemical symbol:

Important: Dispose of according to national regulations.

- a)
- b)
- c)
- d)

- The interior of the product has been cleaned.
- All inlet and outlet ports of the product have been sealed.
- The product has been properly packed, if necessary, please order an original packaging (costs will be charged) and marked as appropriate.
- The carrier has been informed about the hazardous nature of goods (if applicable).

3.2 Important information and precautions, e.g. danger classification

- a)
- b)
- c)
- d)

Signature:

Name (print):

Job title (print):

4. Declaration (please mark as applicable):

Company's seal:

4.1 for non dangerous goods:

Date:

- We assure for the returned product that
- neither toxic, corrosive, biologically active, explosive, radioactive nor contamination dangerous in any way has occurred.
 - the product is free of dangerous substances.

The oil or residues of pumped media have been drained.

4.2 for dangerous goods:

- We assure for the returned product that
- all substances, toxic, corrosive, biologically active, explosive, radioactive or dangerous in any way which have pumped or been in contact with the product are listed in 3.1, that the information is complete and that we have not withheld any information.
 - the product, in accordance with regulations, has been
 - cleaned
 - decontaminated
 - sterilized

10 Spare parts

This chapter lists spare parts, accessories, and optional extras, including all of the relevant order information for ordering from BUCHI. Always state the product designation and part number when ordering any spare parts.

Use only genuine BUCHI consumables and spare parts for maintenance and repair to ensure optimum system performance and reliability. Prior written permission of the manufacturer should be obtained before any modifications are made to the spare parts used.

10.1 Basic instrument

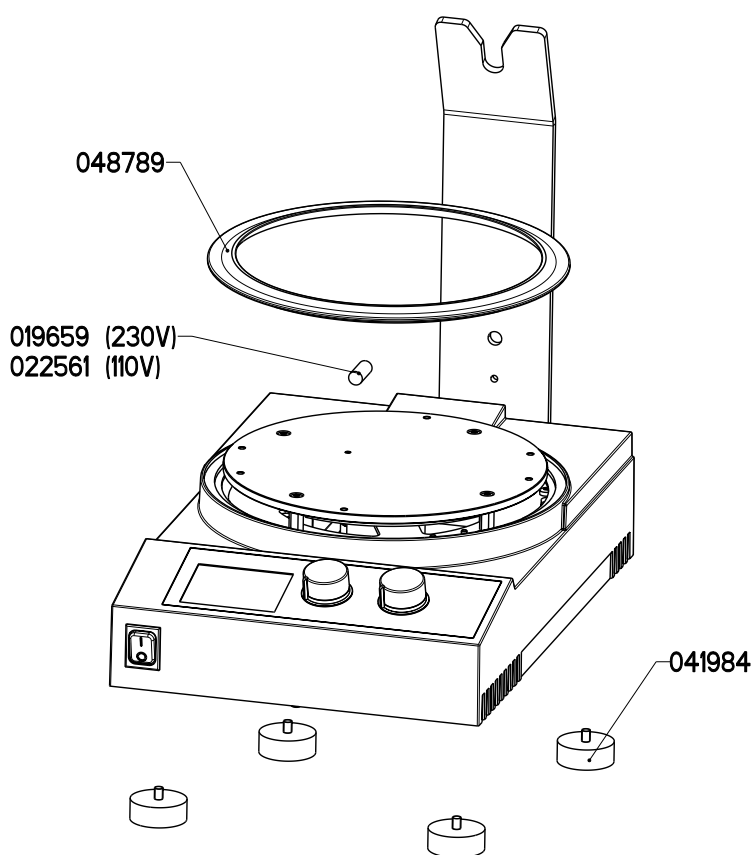
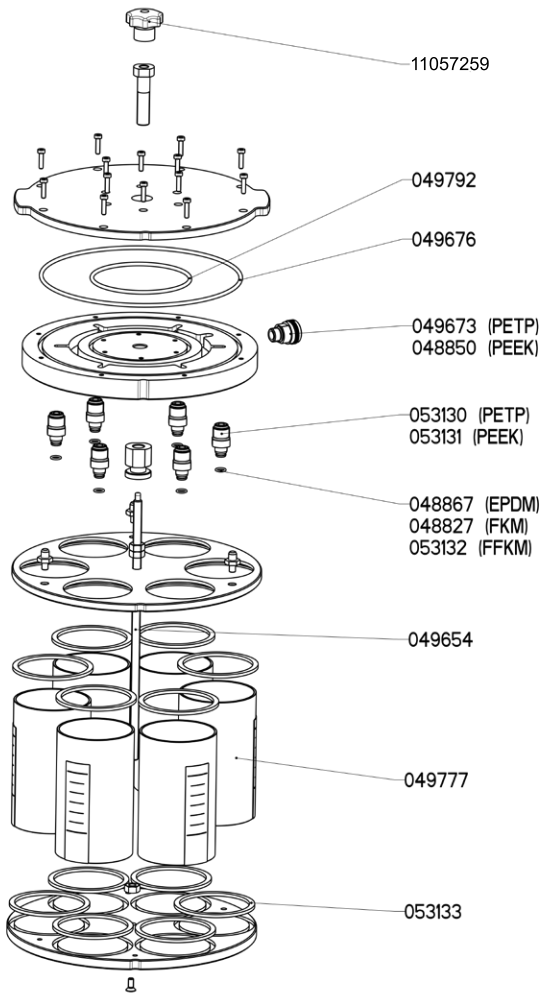

Fig. 10.45: Multivapor platform

Table 10-1: Multivapor platform

Product	Order number	Product	Order number
Multivapor cover ring	48789	Set of main fuses, T 3.1 A L 250 V (for 220–240 V instrument) (10 pieces)	19659
Set of 4 instrument feet	41984	Set of main fuses, T 6.3 A L 250 V (for 100–120 V instrument) (10 pieces)	22561

10.2 Evaporation unit

Table 10-2: Evaporation unit P-6

Product	Order number
Quick lock nut	11057259
Vacuum cover O-ring, small (EPDM)	49792
Vacuum cover O-ring, large (EPDM)	49676
Vacuum cover joint SVL 22 (PETP)	49673
Vacuum cover joint SVL 22 (PEEK)	48850
Set of 6 conical adapters (PETP)	53130
Set of 6 conical adapters (PEEK)	53131
Set of 12 adapter O-rings (EPDM)	48867
Set of 12 adapter O-rings (FKM)	48827
Set of 6 adapter O-rings (FFKM)	53132
Support rod	49654
Glass cylinder P-6 with level indication	49777
Set of 12 cryst rack P-6 seals	53133

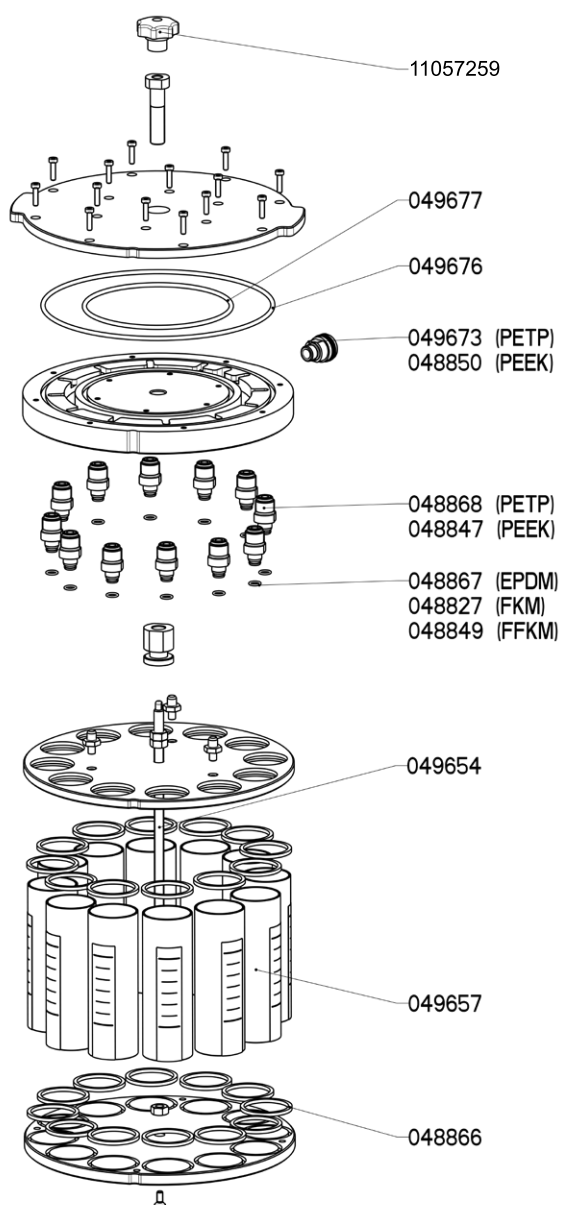

Table 10-3: Evaporation unit P-12

Product	Order number
Quick lock nut	11057259
Vacuum cover O-ring, small (EPDM)	49677
Vacuum cover O-ring, large (EPDM)	49676
Vacuum cover adapter SVL 22 (PETP)	49673
Vacuum cover adapter SVL 22 (PEEK)	48850
Set of 12 conical adapters (PETP)	48868
Set of 12 conical adapters (PEEK)	48847
Set of 12 adapter O-rings (EPDM)	48867
Set of 12 adapter O-rings (FKM)	48827
Set of 12 adapter O-rings (FFKM)	48849
Support rod	49654
Glass cylinder P-12 with level indication	49657
Set of 24 crystal rack P-12 seals	48866

10.3 Adapter sets

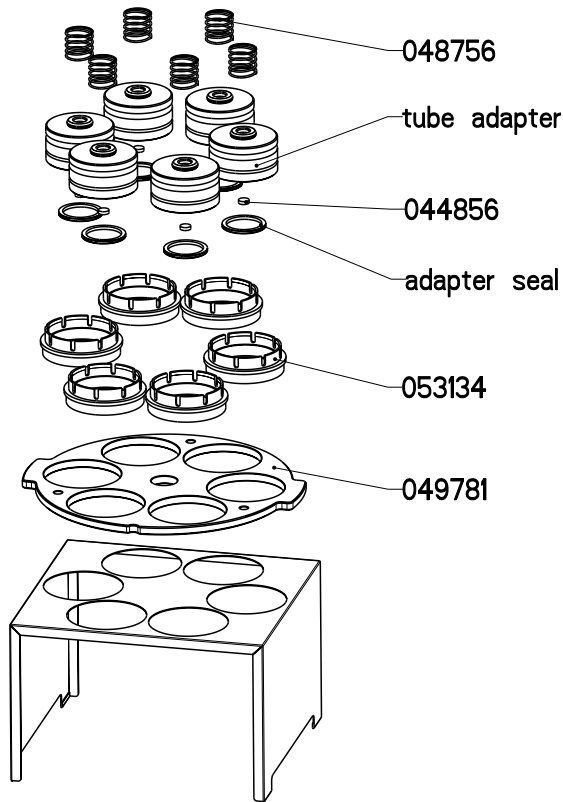

Table 10-4: Adapter set P-6

Product	Order number
Set of 12 adapter springs	48756
Set of 60 PE frits	44856
Set of 6 click adapters P-6	53134
Transfer plate P-6	49781

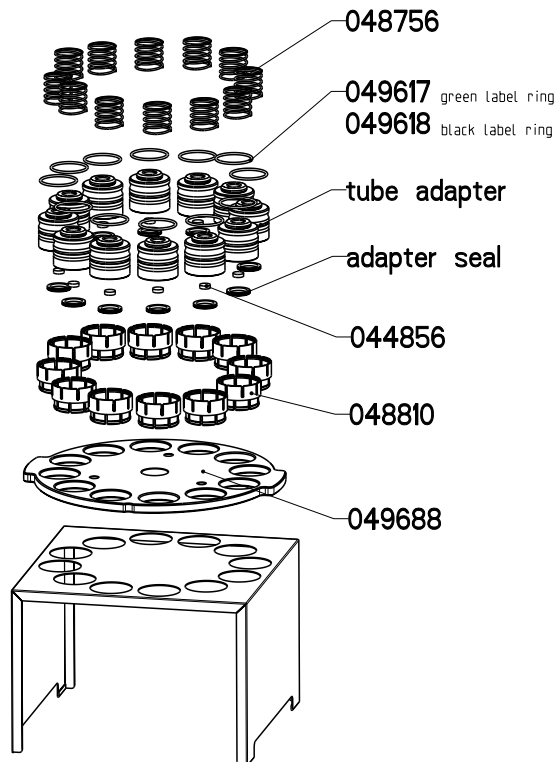

Table 10-5: Adapter set P-12

Product	Order number
Set of 12 adapter springs	48756
Set of 12 green tube adapter label rings	49617
Set of 12 black tube adapter label rings	49618
Set of 60 PE frits	44856
Set of 12 click adapters P-12	48810
Transfer plate P-12	49688

10.4 Condenser assemblies

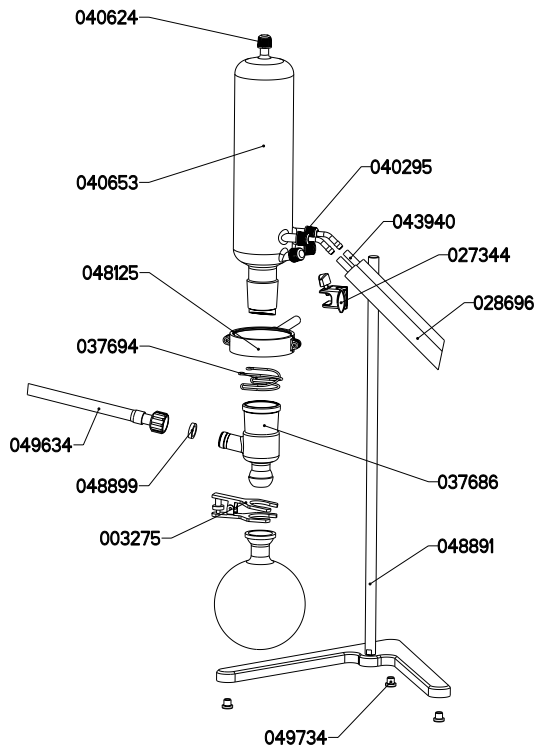

Table 10-6: Condenser assembly type S

Product	Order number
Set of 5 GL14 blind caps	40624
Set of 4 bent GL14 tube connections	40295
Silicon water tube, 1.5 m, ø 6/9 mm	43940
Water tube temperature insulation, 1.5 m, ø 11/23 mm	28696
Type S condenser	40653
Type S condenser clamp	48125
Cross sleeve	27344
KS clip 45/40	37694
KS clip 20/35	03275
T-piece	37686
Ribbed vacuum tube (PFA), 600 mm	49634
Set of 2 vacuum tube seals SVL 22 (PTFE)	48899
Support rod, 600 mm	48891
Set of 3 stand base feet	49734

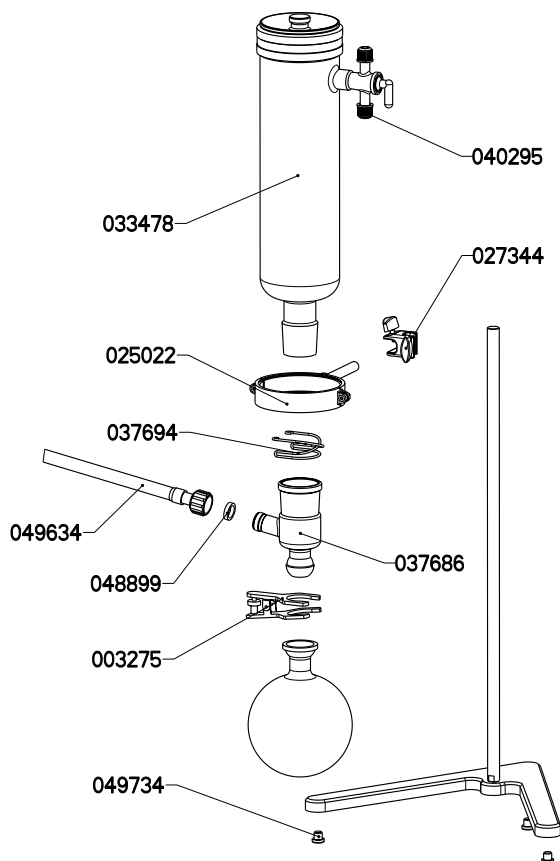

Table 10-7: Condenser assembly type C

Product	Order number
Set of 4 bent GL14 tube connections	40295
Type C condenser	33478
Type C condenser clamp	25022
Cross sleeve	27344
KS clip 45/40	37694
KS clip 20/35	03275
T-piece	37686
Ribbed vacuum tube (PFA), 600 mm	49634
Set of 2 vacuum tube seals SVL 22 (PTFE)	48899
Support rod, 600 mm	48891
Set of 3 stand base feet	49734

10.5 Various glass parts

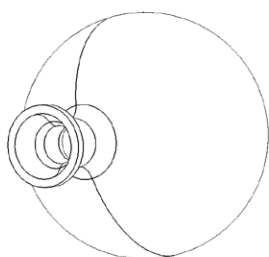
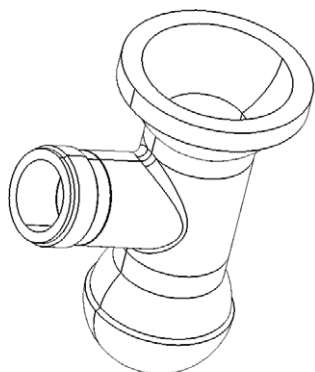

Table 10-8: Rotavapor connection

Product	Order number
T-piece with SVL 22 joint	48812

Table 10-9: Receiving flasks, P+G coated

Product	Order number
Receiving flask type S, 1 L	20728
Receiving flask type S, 2 L	25265
Receiving flask type C, 1 L*	40775
Receiving flask type C, 2 L*	40776

* special low-temperature coating

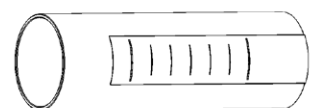
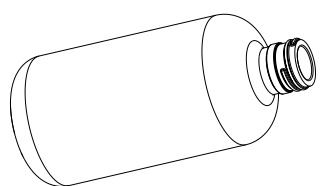
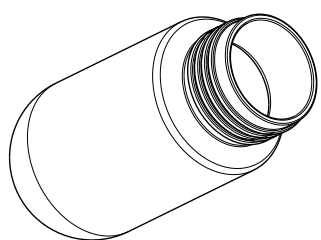
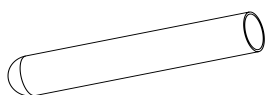
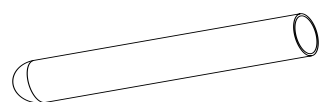
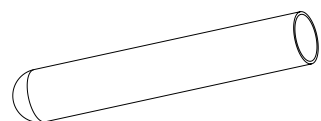
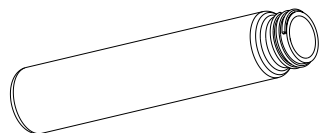
**Table 10-10: Sample vessels**

Product	Order number
Set of 25 round bottom BUCHI P-12 sample vessels with screw cap (GPI 24-400, working volume 30 mL, \varnothing 27 mm, L = 145 mm)	49662
Set of 72 flat bottom PSE/ASE tubes (GPI 24-400, working volume 30 mL)	49535
Set of 50 test tubes OD 25 (25×150 mm)	38469
Set of 100 test tubes OD 20 (20×150 mm)	42845
Set of 100 test tubes OD 16 (16×130 mm)	38543
Set of 6 round bottom BUCHI P-6 sample vessels with screw cap (GL45, working volume 150 mL)	49774
Set of 10 ASE 200 bottles with screw cap (GPI 24-400, working volume 170 mL)	52672

Table 10-11: Glass cylinder

Product	Order number
Glass cylinder for crystal rack P-6 with level indication	49777
Glass cylinder for crystal rack P-12 with level indication	49657

10.6 Miscellaneous

Table 10-12: Documentation

Product	Order number	Product	Order number
Installation and Operation Guide	93163	Multivapor IQ/OQ, English	48822
Multivapor Application Booklet	48858		

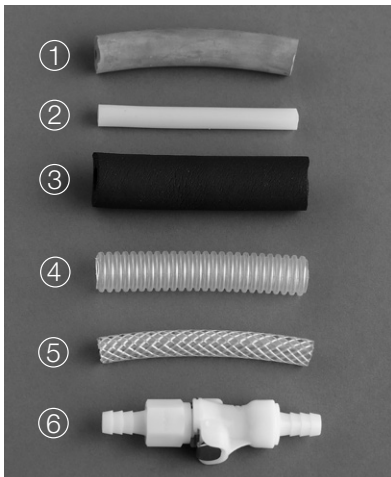
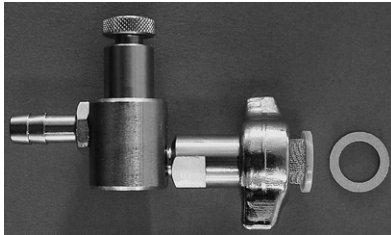

Table 10-13: Water control valves

Product	Order number
Water control valve 1/2", complete	11606
Cooling water valve 24 V for Vacuum Controller V-850 / V-855	31356

Table 10-14: Tubes

Product	Order number
① Vacuum tube, 2 m, \varnothing 16/6 mm	40459
② Cooling water silicone tube, 1.5 m, \varnothing 9/6 mm	43940
③ Temperature insulation for cooling water tube, 1.5 m, \varnothing 11/23 mm	28696
④ Ribbed PFA vacuum tube, 1 m (without SVL 22 joint)	26096
⑤ Nyflex tube, 5 m, \varnothing 5/10 mm	43185
⑥ Set of 2 quick couplings with stop flow mechanism	42885

**Table 10-15: Vacuum solutions**

Product	Order number
Vacuum Controller V-850	47231
Vacuum Controller V-855	47232

Valve unit for combination of the Vacuum Controller V-850 / V-855 with non-BUCHI vacuum pumps	47160
---	-------

Table 10-16: Recirculating chiller

Product	Order number
F-100, 230 V; 50/60 Hz (1400 W)	11056460
F-100, 115 V; 50/60 Hz (1400 W)	11056461
F-108, 230 V; 50/60 Hz (800 W)	11056464
F-108, 115 V; 50/60 Hz (800 W)	11056465

11 Declarations and requirements

11.1 FCC requirements (for USA and Canada)

English:

This equipment has been tested and found to comply with the limits for a Class A digital device, pursuant to both Part 15 of the FCC Rules and the radio interference regulations of the Canadian Department of Communications. These limits are designed to provide reasonable protection against harmful interference when the equipment is operated in a commercial environment.

This equipment generates, uses and can radiate radio frequency energy and, if not installed and used in accordance with the instruction manual, may cause harmful interference to radio communications. Operation of this equipment in a residential area is likely to cause harmful interference in which case the user will be required to correct the interference at his own expense.

Français:

Cet appareil a été testé et s'est avéré conforme aux limites prévues pour les appareils numériques de classe A et à la partie 15 des réglementations FCC ainsi qu'à la réglementation des interférences radio du Canadian Department of Communications. Ces limites sont destinées à fournir une protection adéquate contre les interférences néfastes lorsque l'appareil est utilisé dans un environnement commercial.

Cet appareil génère, utilise et peut irradier une énergie à fréquence radioélectrique, il est en outre susceptible d'engendrer des interférences avec les communications radio, s'il n'est pas installé et utilisé conformément aux instructions du mode d'emploi. L'utilisation de cet appareil dans les zones résidentielles peut causer des interférences néfastes, auquel cas l'exploitant sera amené à prendre les dispositions utiles pour palier aux interférences à ses propres frais.

BUCHI Affiliates:

Europe

Switzerland/Austria

BÜCHI Labortechnik AG
 CH – 9230 Flawil
 T +41 71 394 63 63
 F +41 71 394 65 65
 buchi@buchi.com
 www.buchi.com

Benelux

BÜCHI Labortechnik GmbH
 Branch Office Benelux
 NL – 3342 GT Hendrik-Ido-Ambacht
 T +31 78 684 94 29
 F +31 78 684 94 30
 benelux@buchi.com
 www.buchi.be

France

BUCHI Sarl
 FR – 94656 Rungis Cedex
 T +33 1 56 70 62 50
 F +33 1 46 86 00 31
 france@buchi.com
 www.buchi.fr

Germany

BÜCHI Labortechnik GmbH
 DE – 45127 Essen
 T +800 414 0 414 0 (Toll Free)
 T +49 201 747 49 0
 F +49 201 747 49 20
 deutschland@buchi.com
 www.buechigmbh.de

Italy

BUCHI Italia s.r.l.
 IT – 20010 Cornaredo (MI)
 T +39 02 824 50 11
 F +39 02 575 12 855
 italia@buchi.com
 www.buchi.it

Russia

BUCHI Russia/CIS
 Russia 127287 Moscow
 T +7 495 36 36 495
 F +7 495 98 10 520
 russia@buchi.com
 www.buchi.ru

United Kingdom

BUCHI UK Ltd.
 GB – Oldham OL9 9QL
 T +44 161 633 1000
 F +44 161 633 1007
 uk@buchi.com
 www.buchi.co.uk

Germany

BÜCHI NIR-Online
 DE – 69190 Walldorf
 T +49 6227 73 26 60
 F +49 6227 73 26 70
 nir-online@buchi.com
 www.nir-online.de

America

Brazil

BUCHI Brasil Ltda.
 BR – Valinhos SP 13271-200
 T +55 19 3849 1201
 F +55 19 3849 2907
 brasil@buchi.com
 www.buchi.com

USA/Canada

BUCHI Corporation
 US – New Castle, DE 19720
 T +1 877 692 8244 (Toll Free)
 T +1 302 652 3000
 F +1 302 652 8777
 us-sales@buchi.com
 www.mybuchi.com

Asia

China

BUCHI China
 CN – 200052 Shanghai
 T +86 21 6280 3366
 F +86 21 5230 8821
 china@buchi.com
 www.buchi.com.cn

India

BUCHI India Private Ltd.
 IN – Mumbai 400 055
 T +91 22 667 75400
 F +91 22 667 18986
 india@buchi.com
 www.buchi.in

Indonesia

PT. BUCHI Indonesia
 ID – Tangerang 15321
 T +62 21 537 62 16
 F +62 21 537 62 17
 indonesia@buchi.com
 www.buchi.co.id

Japan

Nihon BUCHI K.K.
 JP – Tokyo 110-0008
 T +81 3 3821 4777
 F +81 3 3821 4555
 nihon@buchi.com
 www.nihon-buchi.jp

Korea

BUCHI Korea Inc.
 KR – Seoul 153-782
 T +82 2 6718 7500
 F +82 2 6718 7599
 korea@buchi.com
 www.buchi.kr

Malaysia

BUCHI Malaysia Sdn. Bhd.
 MY – 47301 Petaling Jaya,
 Selangor
 T +60 3 7832 0310
 F +60 3 7832 0309
 malaysia@buchi.com
 www.buchi.com

Singapore

BUCHI Singapore Pte. Ltd.
 SG – Singapore 609919
 T +65 6565 1175
 F +65 6566 7047
 singapore@buchi.com
 www.buchi.com

Thailand

BUCHI (Thailand) Ltd.
 TH – Bangkok 10600
 T +66 2 862 08 51
 F +66 2 862 08 54
 thailand@buchi.com
 www.buchi.co.th

BUCHI Support Centers:

South East Asia

BUCHI (Thailand) Ltd.
 TH-Bangkok 10600
 T +66 2 862 08 51
 F +66 2 862 08 54
 bacc@buchi.com
 www.buchi.com

Middle East

BÜCHI Labortechnik AG
 UAE – Dubai
 T +971 4 313 2860
 F +971 4 313 2861
 middleeast@buchi.com
 www.buchi.com

Latin America

BUCHI Latinoamérica Ltda.
 BR – Valinhos SP 13271-200
 T +55 19 3849 1201
 F +55 19 3849 2907
 latinoamerica@buchi.com
 www.buchi.com

We are represented by more than 100 distribution partners worldwide.
 Find your local representative at: www.buchi.com