

# PREMIUM LABORATORY EQUIPMENT



Rotary Evaporators

AWARD-WINNING  
EVAPORATION SYSTEMS



## Don't compromise

**Heidolph Premium laboratory equipment stands for reliability, precision, and efficiency. Your demand drives us to provide the fastest service, individual support, and quality without compromise. So that you can keep your head clear to successfully drive forward the research work for your company, organization or institution. Briefly: "research made easy".**

That's why "Made in Germany" is much more than a marketing strategy for us: It's part of our corporate philosophy.

Our location in Germany enables us to develop and manufacture reliable laboratory equipment for years of continuous use with an average service life of more than 10 years. This makes your purchase a worthwhile investment in the future.

All Heidolph products are developed and manufactured at our Schwabach headquarters in Nuremberg; they go through a multi-stage quality checks. Powerful, maintenance free motors ensure constant results even in continuous operation, preventing downtime and costly repairs.

For us, premium service means: individual and application-related advice, competent and professional installation and instruction as well as the shortest possible repair and delivery times – simply "research made easy".

MADE IN  
GERMANY

**3-year warranty on all devices and an average operational lifespan of 10 years**

**Multi-stage quality checks in development and production**

**Premium service according to the "research made easy" principle**

**Test our devices before you decide!**

Schedule an appointment for an online demo presentation from our showroom.

## Contents

5	<b>Hei-VAP Rotary Evaporators</b>
9	All benefits at a glance
10	The Hei-VAP series
12	Hei-VAP Core
14	Hei-VAP Expert/Ultimate
16	Hei-VAP Expert Control/Ultimate Control
18	The Hei-VAP Control principle
19	Automatic boiling point detection
20	Technical specifications
22	Glassware sets
23	Glass accessories
24	Further accessories
26	Automatic benchtop module
27	Principle of operation
28	Vacuum controller
29	<b>Hei-VAC Vacuum Pumps</b>
30	Diaphragm vacuum pumps
31	Speed-controlled vacuum pumps
32	<b>Hei-CHILL Recirculation Chillers</b>
33	Accessories
34	Technical specifications
35	Packages
39	<b>Hei-VAP Large-scale Evaporators</b>
43	All benefits at a glance
44	Hei-VAP Industrial
45	Vacuum regulation
46	Technical specifications
47	Glassware sets
48	Accessories
49	Vacuum pump/Industrial recirculation chiller
50	Technical specifications
51	Packages
52	Industrial automatic module
53	Principle of operation
54	Accessories
56	Packages
56	<b>Best Service</b>



Focus on what really matters.

Dr. Vladimir Malakhov  
Group of Prof. Dr. Paul Knochel,  
Department of Chemistry  
Ludwig-Maximilians-  
Universität München



### The Heidolph Stories

What our users say about working together during the development of the new Hei-VAP series.

**Find out more here.**



## Hei-VAP Rotary Evaporators Developed with Users

Working in close cooperation with users, the Hei-VAP Series rotary evaporators got to the heart of the matter: well thought out details with the focus on what is essential, to make the everyday laboratory work easier. Diverse combinations with condensers and extensive accessories offer the right configuration for every application. Perfectly matched peripheral devices round off the rotary evaporators to create complete systems – all from a single source.

This overall package has already convinced three different independent juries. The new Hei-VAP Series was not only chosen as the most innovative laboratory equipment of 2019, but also received the Red Dot Design Award and the iF Design Award for its user-friendly screen design.

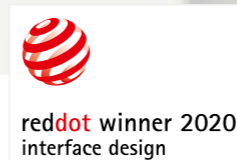
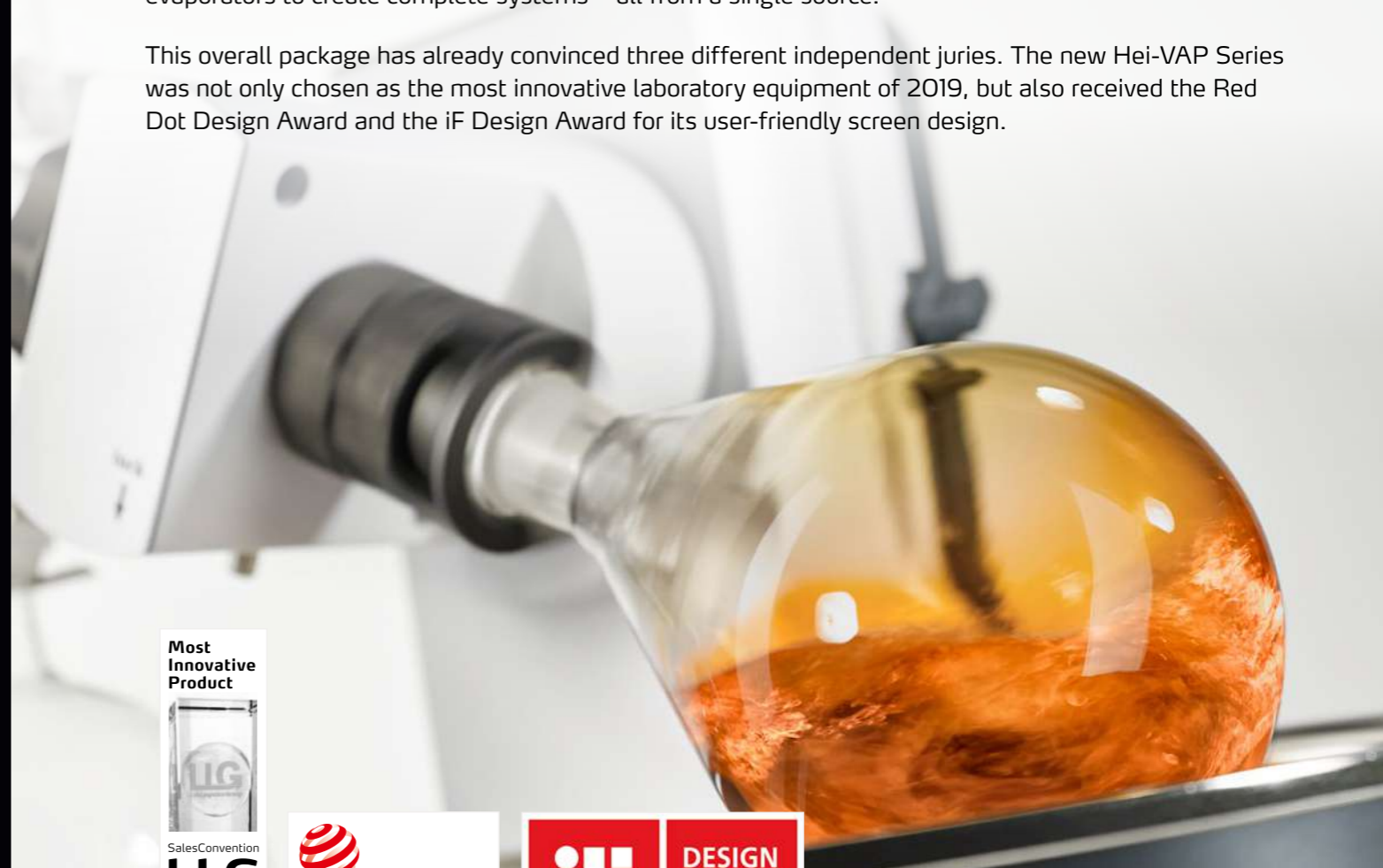



## Leading Safety Standards

- Universally usable safety heating bath with overheating and dry running protection, ergonomic handles, double wall and integrated spout. The stable metal connection to the device base enables variable heating bath positioning without the risk of tilting
- The digital display allows direct control of the current values. Thanks to protection class IP 42, the electronics are reliably protected against dripping water and dust. To prevent short-circuits and corrosion, the electrical cable connections of the operating panel and the heating bath connection meet protection class IP 67
- Separate rotary knobs with intuitive LED ring light system simplify visual process control and allow direct intervention in the evaporation process at any time. A lock function prevents inadvertent adjustment of the values
- The standby button stops all functions and in motor driven lift models it moves the evaporator flask out of the heating bath. In this mode or with disabled function, flashing of the LED ring and display of the residual heat warn of a risk of burns (> 50 °C)
- Additional safety from a single source: from the transparent plastic coating of the glassware sets to the guard shield and guard hood (implosion protection) through to IQ-OQ acceptance and documentation



## Superior Ease of Use

- All models are available as a manual lift or motor driven lift variant
- The patented Easy-Clip retort clamp facilitates attaching and changing the evaporation flask considerably. Stuck ground joints are separated gently, to prevent glass breakage
- The removable control panel with digital display or innovative touch display with the optional cable extension enables fast and convenient operation outside closed fume hoods
- Intuitive operation, since all settings are made centrally at the control panel. Used in conjunction with the Control Box it becomes the central control unit and additionally controls the vacuum pump and Hei-CHILL recirculation chiller
- Easy venting thanks to polished chiller setup: Venting cap with PTFE inlay and threaded joint prevents sticking glass – completely without greasing. A vent valve with refill function is available as an option
- FDA compliant materials for all components actively and passively touched by media enable an extended range of applications
- Practical unlocking for individual setting of the tilt angle from 20° to 80° and vertical stop for limiting the immersion depth up to 150mm
- The optionally available automatic Hei-VOLUME Distimatic module enables fully automatic filling and draining in unattended and continuous use





## Reduced Cost of Ownership

- No unnecessary extra costs: The patented clamping sleeve effectively prevents sticking of the vapor tube in the drive
- Stuck evaporator flasks can be released safely by the push-off function of the patented Easy-Clip
- Polished chiller setup with grease-free threaded joints prevents glass breakage
- The highly resistant and particularly durable PTFE vacuum seals achieve maximum tightness and save long-term spare parts costs
- The unique tightness of the vacuum system leads to shorter process times, reduced energy costs and purer results
- Even more efficiency with up to 40 % higher evaporation rates: The intelligent design of the XL chiller enables 57 % more cooling surface than previous standard vertical chillers with virtually the same overall height
- Corrosion-free die-cast housing with condensation-repelling paint formula and maintenance-free motors ensure unlimited continuous use as well as a long life with low maintenance costs
- Plastic parts touched by media such as the screw connection for fixing the chiller and the clamping sleeve on the vapor tube are made of highly resistant PPS for a long life
- The current series is forward and backward compatible with many spare and wearing parts of the previous models



MADE IN  
GERMANY

All Benefits at a Glance

3-year warranty on all devices and an average operational lifespan of 10 years

## Intelligent Distillation



Up to 40% higher evaporation rate with a cooling surface of 2,200 cm<sup>2</sup> for all XL condensers

High-resistance and durable PTFE vacuum seals for many years of continuous use

Patented components such as the Easy-Clip with flask push-off function and a clamping sleeve for protecting the vapor tube prevent sticking glass parts

The 210 °C safety heating bath has handles and spout and switches off in case of low water level and 5 °C overtemperature

Cable connections with protection class IP 67 protect against corrosion and short-circuits

Polished cooler set-up: Venting cap with PTFE inlay and threaded joint prevents sticking glass

Available with digital display or innovative touch display – also with Control Box on request as Control variant for additional control of vacuum and Hei-CHILL recirculation chiller

For fast access, all models have additional separate rotary knobs with LED rings for display of the active functions

In conjunction with the automatic module Hei-VOLUME Distimatic process high volumes in 24/7 operation fully automatically. The inexpensive alternative to the large-scale evaporator.

Standby function and residual heat warning at heating bath temperatures over 50 °C

Metal connection to the basic console prevents the filled bath from tilting

# The Hei-VAP series – one concept

# for all requirements

## Standard Models

Without vacuum control. For integration in an existing vacuum system or for configuration with external vacuum controller.



### Hei-VAP Core

- Digital display
- Direct access to heating bath temperature and rotation speed
- Lock function
- Standby button
- Residual heat indicator



### Hei-VAP Expert

- 5" touch display
- Clear display of all valves (Basic/Advanced modes)
- Timer
- Limiting of the heating temperature
- Multilingual menu with text warnings
- Optional display of the boiling temperature
- USB and Micro-SD interfaces



### Hei-VAP Ultimate

- 7" touch display
- Clear display of all valves (Basic/Advanced modes)
- Timer
- Limiting of the heating temperature
- Multilingual menu with text warnings
- Optional display of the boiling temperature
- USB and Micro-SD interfaces as well as LAN/RS 232 interfaces (Lab 4.0-ready)

## Control Models

Including smarter control box. For control of any vacuum source as well as the Hei-CHILL recirculation chiller directly via the control panel of the rotary evaporator.



### Hei-VAP Expert Control

Extends the functions of the Hei-VAP Expert to include:

- Control of any vacuum sources and Heidolph recirculation chillers
- Solvent library
- Favorites memory
- Automatic boiling point determination and distillation (DAA, see page 19)
- Ramp programming



### Hei-VAP Ultimate Control

Extends the functions of the Hei-VAP Ultimate to include:

- Control of any vacuum sources and Heidolph recirculation chillers
- Solvent library
- Favorites memory
- Automatic boiling point determination and distillation (DAA, see page 19)
- Ramp programming

# Hei-VAP Core

## Uncompromising quality and easy to use

An operating concept that is focused on the essentials: clear and with access to the basic parameters – rotation speed and heating bath temperature.

- Clear digital display of actual and set values
- Two separate rotary knobs with dynamic control for setting the rotation speed and heating bath temperature: fast turning for large jumps, slow turning for precise setting of the set values
- Accidental adjustment of the values can be prevented by the lock function
- The LED rings indicate the function is active and is also easily visible from a larger distance
- Easy setting of the immersion depth up to 155 mm and the tilt angle of the evaporation flask from 20° to 80°
- Standby function and residual heat warning at heating bath temperatures over 50 °C
- Available as a manual lift or motor driven lift



Hei-VAP Core	Manual lift (HL)		Motor driven lift (ML)	
	standard	coated	standard	coated
G1 diagonal condenser	571-01100-00	571-01110-00	572-01100-00	572-01110-00
G3 vertical condenser	571-01300-00	571-01310-00	572-01300-00	572-01310-00
G3 XL vertical condenser	571-01305-00	571-01315-00	572-01305-00	572-01315-00
G5 dry ice condenser	571-01500-00	571-01510-00	572-01500-00	572-01510-00
G6 reflux condenser	571-01600-00	571-01610-00	572-01600-00	572-01610-00



The standby button stops all functions and in motor driven lift models it moves the evaporator flask out of the heating bath .

**Hei-VAC Control**  
The optional extension for precise regulation of the in-house vacuum or diaphragm vacuum pumps

# Hei-VAP Expert / Ultimate

With a clear 5" or 7" touch display

With the Hei-VAP Expert, all values are always in view.

- Central control panel with a 5" touch display
- Clear display of all valves (Basic and Advanced modes)
- With timer, limiting of the heating temperature, multilingual menu and text display of error messages
- Separate rotary controller for rotation and heating temperature with lock function against accidental adjustment
- LED rings and pictogram for display of the activity, including from a distance
- Integrated solvent library for facilitating setting of the optimal rotation speed and heating bath temperature, including indication of the necessary vacuum
- USB and Micro-SD interfaces
- All process data can be stored and transferred via a USB stick
- Optional boiling temperature display



Rotation speed and heating bath temperature can be set exactly on the digital touch display or – for fast access during the process – directly via the rotary controller on the control panel.

Subsequent upgrade to Hei-VAP Expert Control/Ultimate Control possible with vacuum and cooler control.

See pages 20–21

Hei-VAP Expert	Manual lift (HL)		Motor driven lift (ML)	
	standard	coated	standard	coated
<b>G1 diagonal condenser</b>	573-01100-00	573-01110-00	574-01100-00	574-01110-00
<b>G3 vertical condenser</b>	573-01300-00	573-01310-00	574-01300-00	574-01310-00
<b>G3 XL vertical condenser</b>	573-01305-00	573-01315-00	574-01305-00	574-01315-00
<b>G5 dry ice condenser</b>	573-01500-00	573-01510-00	574-01500-00	574-01510-00
<b>G6 reflux condenser</b>	573-01600-00	573-01610-00	574-01600-00	574-01610-00



Hei-VAP Ultimate differs from the Hei-VAP Expert due to:

- 7" touch display – so that all values are always in view, even from a larger distance
- LAN/RS 232 interfaces

Hei-VAP Ultimate	Manual lift (HL)		Motor driven lift (ML)	
	Standard	Coated	Standard	Coated
<b>G1 diagonal condenser</b>	575-01100-00	575-01110-00	576-01100-00	576-01110-00
<b>G3 vertical condenser</b>	575-01300-00	575-01310-00	576-01300-00	576-01310-00
<b>G3 XL vertical condenser</b>	575-01305-00	575-01315-00	576-01305-00	576-01315-00
<b>G5 dry ice condenser</b>	575-01500-00	575-01510-00	576-01500-00	576-01510-00
<b>G6 reflux condenser</b>	575-01600-00	575-01610-00	576-01600-00	576-01610-00



# Hei-VAP Expert Control / Ultimate Control

## Central control unit for uncompromising precision

Supplements the Hei-VAP Expert with a large number of smart functions and creates an overview of all parameters and the current process.

### Hei-VAP Expert Control

- 5" touch display for control of the overall system including the vacuum and the cooling temperature
- For precise monitoring, the pictogram on the display symbolizes additional active functions
- Separate rotary controllers for fast access, the right-hand one for direct vacuum control, the left-hand one for the rotation
- Setting of the values optionally via the touch display or the rotary controller
- Direct access to favorites via short-cut keys
- Expandable solvent library: Own favorites can be transferred to other devices with a USB stick
- Define and save own evaporation processes (ramps)
- Automatic evaporation with the Dynamic AUTO<sub>accurate</sub> program (DAA). Convenient and adaptable from foam prevention to high-efficiency evaporation
- With USB and Micro-SD interfaces for easy installation of software updates
- All process data can be stored and transferred via a USB stick



Control panel for central control and regulation of the vacuum – including the cooling temperature in conjunction with a Hei-CHILL recirculation chiller. With solvent library, favorites, individual ramps and smart automatic programs.



### Hei-VAP Ultimate Control

differs from the Hei-VAP Expert Control due to:

- 7" touch display – so that all values are always in view, even from a larger distance
- Additional LAN / RS 232 interfaces



Hei-VAP Expert Control	Manual lift (HL)		Motor driven lift (ML)	
	Standard	Coated	Standard	Coated
<b>G1 diagonal condenser</b>	573-02100-00	573-02110-00	574-02100-00	574-02110-00
<b>G3 vertical condenser</b>	573-02300-00	573-02310-00	574-02300-00	574-02310-00
<b>G3 XL vertical condenser</b>	573-02305-00	573-02315-00	574-02305-00	574-02315-00
<b>G5 dry ice condenser</b>	573-02500-00	573-02510-00	574-02500-00	574-02510-00
<b>G6 reflux condenser</b>	573-02600-00	573-02610-00	574-02600-00	574-02610-00

Hei-VAP Ultimate Control	Manual lift (HL)		Motor driven lift (ML)	
	Standard	Coated	Standard	Coated
<b>G1 diagonal condenser</b>	575-02100-00	575-02110-00	576-02100-00	576-02110-00
<b>G3 vertical condenser</b>	575-02300-00	575-02310-00	576-02300-00	576-02310-00
<b>G3 XL vertical condenser</b>	575-02305-00	575-02315-00	576-02305-00	576-02315-00
<b>G5 dry ice condenser</b>	575-02500-00	575-02510-00	576-02500-00	576-02510-00
<b>G6 reflux condenser</b>	575-02600-00	575-02610-00	576-02600-00	576-02610-00

# The Hei-VAP Control principle

Hei-VAP Expert Control and Ultimate Control are central control units for controlling all process parameters: Vacuum, cooling temperature, rotation and heating bath temperature.



Hei-VAP Expert Control  
Hei-VAP Ultimate Control

\*Subsequent upgrading also possible – simply connect the Control Box by plug-and-play and enjoy all the advantages.

Evaporation with one fingertip:

- Individualizable solvent database
- Find boiling point automatically by Dynamic AUTO<sub>accurate</sub>
- Simply save the process as a favorite

## Save time with the automatic boiling point detection

### Dynamic AUTO<sub>accurate</sub> (DAA)

- The boiling points of one or multiple fractions are detected via the steam temperature profile of the mixture with continuous automatic vacuum control
- Whether one or multiple fractions are to be distilled can be freely set. The vacuum regulation takes place completely automatically for each fraction
- The evaporation speed is controlled via a settable ratio of steam to cooling temperature

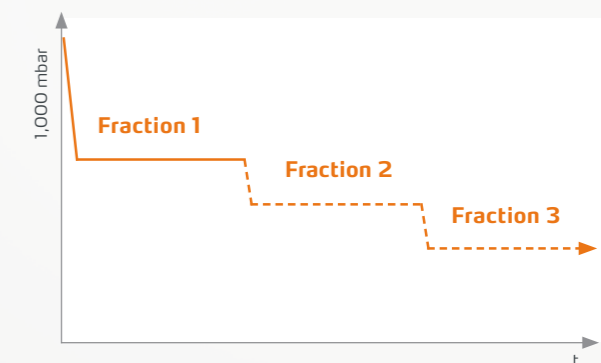

With DAA a completely automated distillation process can be started during the heating up phase of the heating bath. The system pressure is adjusted dynamically to the changing heating bath temperature, until the heating bath has reached the set temperature.

- The samples are distilled precisely
- The automation with sensors ensures significantly higher accuracy
- To protect your sample, in motor driven lift models the evaporation flask moves out of the heating bath automatically when the process has ended

### System requirements:

Hei-VAP Expert Control or Hei-VAP Ultimate Control with AUTO<sub>accurate</sub> sensor for using the automatic process control and configuration with glassware (G3, G3 XL or G6)

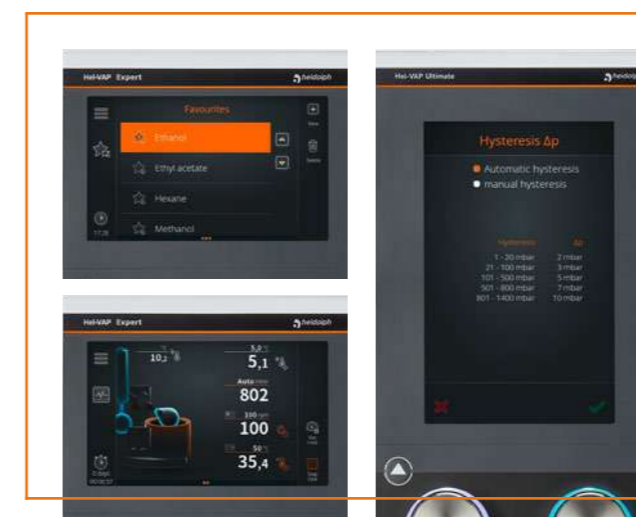

### Favorites and ramps

- Solvent library with preset, adjustable processes and solvents. Can be saved as a favorite at any time, including directly on the Home screen
- Individually created favorites and ramps can be transferred by USB stick to other Hei-VAP Expert or Ultimate devices
- Adjust individually: Set hysteresis (from low to maximum capacity utilization), limiting of max. pressure or temperature, multi-lingual menu with format settings, different calibrations, assignment of the right rotary knob with heating temperature or vacuum

# Technical Specifications

## Rotary evaporator

Model	Hei-VAP Core (HL)	Hei-VAP Core (ML)	Hei-VAP Expert (HL/ML)	Hei-VAP Ultimate (HL/ML)	Hei-VAP Expert Control (HL/ML)	Hei-VAP Ultimate Control (HL/ML)
<b>Lift</b>	Manual lift	Motor driven lift	Manual lift / Motor drive lift	Manual lift / Motor drive lift	Manual lift / Motor drive lift	Manual lift / Motor drive lift
<b>Lifting speed</b>	manual	30 mm/s	manual / 30 mm/s	manual / 30 mm/s	manual / 30 mm/s	manual / 30 mm/s
<b>Stroke</b>	155 mm	155 mm	155 mm	155 mm	155 mm	155 mm
<b>Speed range</b>	10–280 rpm	10–280 rpm	10–280 rpm	10–280 rpm	10–280 rpm	10–280 rpm
<b>Rotation speed indicator</b>	3.5" LCD display	3.5" LCD display	5" LCD color display	7" LCD color display	5" LCD color display	7" LCD color display
<b>Motor</b>	Brushless direct current motor with electronic speed control		Brushless direct current motor with electronic speed control			
<b>Heating power</b>	1,300 W	1,300 W	1,300 W	1,300 W	1,300 W	1,300 W
<b>Temperature range heating bath</b>	20–210 °C	20–210 °C	20–210 °C	20–210 °C	20–210 °C	20–210 °C
<b>Heating bath setting accuracy</b>	±1 °C	±1 °C	±1 °C	±1 °C	±1 °C	±1 °C
<b>Overtemperature protection</b>	Cut-off at 5 °C above set temperature (with separate Pt 1000)		Cut-off at 5 °C above set temperature (with separate Pt 1000)			
<b>Overtemperature limiter</b>	250 °C	250 °C	250 °C	250 °C	250 °C	250 °C
<b>Heating bath temperature display</b>	3.5" LCD display	3.5" LCD display	5" LCD color display	7" LCD color display	5" LCD color display	7" LCD color display
<b>Heating bath temperature control</b>	electronic / digital	electronic / digital	electronic / digital	electronic / digital	electronic / digital	electronic / digital
<b>Heating bath material</b>	Stainless steel V4A (1.4404)	Stainless steel V4A (1.4404)	Stainless steel V4A (1.4404)	Stainless steel V4A (1.4404)	Stainless steel V4A (1.4404)	Stainless steel V4A (1.4404)
<b>Heating bath diameter</b>	255 mm	255 mm	255 mm	255 mm	255 mm	255 mm
<b>Heating bath volume</b>	4.5 l	4.5 l	4.5 l	4.5 l	4.5 l	4.5 l
<b>Evaporation flask max size</b>	5 l	5 l	5 l	5 l	5 l	5 l
<b>Boiling temperature display required accessories</b>	–	–	yes Vapor temperature sensor	yes Vapor temperature sensor	yes Vapor temperature sensor	yes Vapor temperature sensor
<b>Vacuum controller integrated</b>	–	–	–	–	yes	yes
<b>Hei-CHILL recirculation chiller integrated</b>	–	–	–	–	yes	yes
<b>Timer</b>	–	–	yes	yes	yes	yes
<b>Vacuum control mode DAA-Mode requires AUTO<sub>accurate</sub> sensor</b>	–	–	–	–	yes	yes
<b>Programming of ramps</b>	–	–	yes	yes	yes	yes
<b>Recording of process data</b>	–	–	yes	yes	yes	yes
<b>Connected load</b>	1,400 W	1,400 W	1,400 W	1,400 W	1,400 W	1,400 W
<b>Weight without glassware</b>	16 kg	16 kg	16 kg	16 kg	16 kg	16 kg
<b>Dimensions with glassware G3 max. w/d/h</b>	739×477×845 mm	739×477×845 mm	739×477×845 mm	739×477×845 mm	739×477×845 mm	739×477×845 mm
<b>Dimensions with glassware G3 XL max. w/d/h</b>	739×477×920 mm	739×477×920 mm	739×477×920 mm	739×477×920 mm	739×477×920 mm	739×477×920 mm
<b>Cooling surface</b>	1,400 cm <sup>2</sup>	1,400 cm <sup>2</sup>	1,400 cm <sup>2</sup>	1,400 cm <sup>2</sup>	1,400 cm <sup>2</sup>	1,400 cm <sup>2</sup>
<b>XL condenser cooling surface</b>	2,200 cm <sup>2</sup>	2,200 cm <sup>2</sup>	2,200 cm <sup>2</sup>	2,200 cm <sup>2</sup>	2,200 cm <sup>2</sup>	2,200 cm <sup>2</sup>
<b>Permissible ambient conditions</b>	5–31 °C at 80 % rel. humidity, 32–40 °C linearly decreasing to max. 50 % rel. humidity		5–31 °C at 80 % rel. humidity, 32–40 °C linearly decreasing to max. 50 % rel. humidity			
<b>Degree of protection <sup>1</sup> EN 60529</b>	IP 20	IP 20	IP 20	IP 20	IP 20	IP 20

Standard supply voltage: 230 V. Other supply voltages on request.

<sup>1</sup> IP 67 for heating bath connection cable, IP 42 for controls (and Control Box)

# Glassware Sets

- Scope of delivery with one 1,000-ml evaporation and one 1,000-ml receiving flask in each set
- Standard joint size is NS 29/32, NS 24/29 ground joints are available on request
- With venting cap and flat joints for easy handling and grease-free evaporation
- Optional venting valve with function for precise dosing available
- Only the glassware sets G3/G3 XL and G6 are suitable for DAA with Hei-VAP Expert/Ulimate Control
- All glassware sets also with transparent plastic coating, for temperature ranges up to max. 80 °C

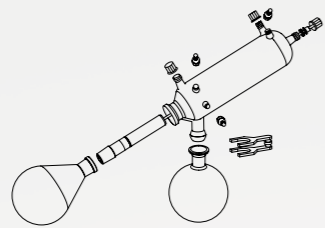

G1

### Glassware G1

Glassware with diagonal condenser for all standard distillations, the cost-effective variant

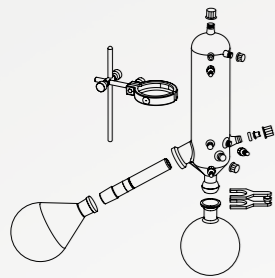

G3

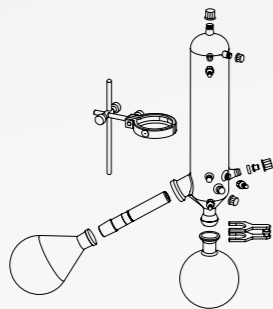

G3 XL

### Glassware G3

Glassware with vertical condenser for all standard distillations, the space-saving variant

### Glassware G3 XL

Up to 40% higher evaporation performance due to 2,200 cm<sup>2</sup> cooling surface

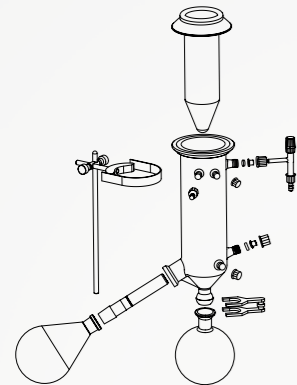

G5

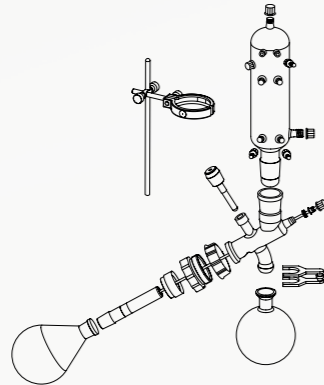

G6

### Glassware G5

Glassware with dry ice chiller for low-boiling solvents

### Glassware G6

Glassware with vertical condenser for reflux distillations

Evaporation rate <sup>1</sup>	Toluene	Acetone	Ethanol	Isopropanol (IPA)	Water
G3 vertical condenser	6.5 l/h	6.0 l/h	2.5 l/h	4.0 l/h	1.4 l/h
G3 XL vertical condenser	8.5 l/h	7.5 l/h	3.5 l/h	4.9 l/h	1.4 l/h
Added performance for XL condensers	31%	25%	40%	23%	System limit reached with 1.4 l/h

<sup>1</sup> At maximum condenser capacity utilization

# Glass Accessories



### Evaporation flask

- 50 ml
- 100 ml
- 250 ml
- 500 ml
- 1000 ml
- 2000 ml
- 3000 ml
- 5000 ml

#### NS 29/32

- 514-70000-00
- 514-71000-00
- 514-72000-00
- 514-73000-00
- 514-74000-00
- 514-75000-00
- 514-76300-00
- 514-78000-00

#### NS 24/29

- 514-70000-01
- 514-71000-01
- 514-72000-01
- 514-73000-01
- 514-74000-01
- 514-75000-01
- 514-76300-01
- 514-78000-03



### Receiving flask

- 100 ml
- 250 ml
- 500 ml
- 1000 ml
- 2000 ml
- 3000 ml

#### Standard

- 514-81000-00
- 514-82000-00
- 514-83000-00
- 514-84000-00
- 514-85000-00
- 514-87000-00

#### coated

- 514-81000-02
- 514-82000-02
- 514-83000-02
- 514-84000-02
- 514-85000-02
- 514-87000-02



### Powder flask

- 500 ml
- 1000 ml
- 2000 ml

#### NS 29/32

- 514-73200-00
- 514-74200-00
- 514-75300-00

#### NS 24/29

- 514-73200-01
- 514-74200-01
- 514-75300-01



### Spider NS 14.5

- With 6 distillation sleeves à 20 ml
- With 12 distillation sleeves à 20 ml
- With 20 distillation sleeves à 20 ml

#### NS 29/32

- 15-300-005-09
- 15-300-005-10
- 15-300-005-11

#### NS 24/29

- 15-300-005-12
- 15-300-005-13
- 15-300-005-06



### Spider NS 24

- With 5 flasks à 50 ml
- With 5 flasks à 100 ml

#### NS 29/32

- 15-300-005-04
- 15-300-005-07

#### NS 24/29

- 15-300-005-08
- 15-300-005-05



### Evaporation cylinder

- 500 ml
- 1,500 ml

#### NS 29/32

- 514-00070-00
- 514-00071-00

#### NS 24/29

- 514-00070-01
- 514-00071-01



### Foam brake

Foam brake incl. retort clamp

#### NS 29/32

- 514-00004-00

#### NS 24/29

- 514-00005-00

Standard joint size is NS 29/32, NS 24/29 ground joints are also available on request

## Further Accessories



### Guard hood

Consists of resistant, highly transparent plastic, for protection against implosions, easy and fast access to the flask and the heating bath, up to max. 130° C

**P/N 569-00010-00**



### Guard shield

Consists of resistant, highly transparent plastic, is fixed onto the edge of the heating bath

**P/N 569-00020-00**



### Aqua-Stop

Closes the water supply automatically, as soon as the rotary evaporator is switched off. Prevents unnecessary water consumption and water damage, and lowers costs

**P/N 569-00500-00**



### Replenishment valve

Polished, for precise dosing while the process is running, with venting function

**P/N 514-51100-00**



### Extension cable

Required for operation outside closed fume hoods, length 1.5 m

**P/N 14-300-020-12**



### Panel bracket

For positioning next to the device or on the wall – for all Hei-VAP operating panels

**P/N 569-01000-00**



### Spare vapor tube

Standard joint size is NS 29/32, NS 24/29 ground joints are also available on request

**P/N 514-00000-01**

### Vapor tube with powder filter

**P/N 514-00000-06**

### Spare clamping sleeve

**P/N 23-30-01-05-31**



### Tubing set

Tube for connection to vacuum and water. Set with 12 m tube and tube clamps

**P/N 591-35000-00**

### Individual length, sold by the meter

**P/N 591-33000-01**



### PTFE/FFKM vacuum seal

Special PTFE seal with FFKM ring seal, maximum chemical resistance, long running period without abrasion, maximum tightness, FDA compliant

**P/N 23-30-01-06-70**

### Standard PTFE/FFKM spare seal

**P/N 23-30-01-01-30**



### Woulff bottle

For separating condensate to protect the vacuum valves, for use with standard vacuum laboratory bottles. Screw connection for easy draining and cleaning, compatible with all Hei-VAP Benchtop configurations, volume 200 ml

**P/N 569-00071-00**



### Vacuum valve

Required for vacuum regulation for Hei-VAP Control models with valve-controlled vacuum pump, easily accessible and easy to clean due to positioning. Is not required for manual vacuum regulation

**P/N 569-00065-00**



### Switchbox

**Connects three evaporators to a vacuum pump**  
Switches the vacuum pump off automatically, if a vacuum is not required or on reaching the set vacuum. This avoids increased energy consumption. In applications with different pressure settings, a vacuum and a non-return valve are necessary for each evaporator. Scope of delivery with three non-return valves.

Only suitable for use with Hei-VAP Control models

Weight 0.6 kg,  
W/D/H 80×160×45 mm

**P/N 569-00400-00**



### Heating bath liquid

Heating bath liquid up to 170 °C (5 l)

**P/N 515-31000-0**

### Up to 220 °C (5 l)

**P/N 569-00600-0**



### AUTO<sub>accurate</sub> sensor

For Hei-VAP Expert Control and Hei-VAP Ultimate Control. Only compatible in combination with glassware G3, G3 XL or G6

**P/N 569-00040-00**



### Vapor temperature sensor

For Hei-VAP Expert and Hei-VAP Ultimate as well as the Control models

**P/N 569-00030-00**

## UPGRADE



### Control-Box

For Hei-VAP Expert and Hei-VAP Ultimate for easy retrofitting of the control function and control of the peripheral devices (vacuum and Hei-CHILL recirculation chillers)

**P/N 569-00200-00**

# Automatic Benchtop Module

## Hei-VOLUME Distimatic

### Easy optimization of process efficiency and precision:

- Automatic supply and removal of initial mixture, distillate and residue drainage (optional)
- Individual determination of the concentration of the end product, to prevent drying, crystallization and formation of powder
- Automated feeding of small volumes to prevent foaming
- The stock and product containers can also be replaced while the process is running

- Permanent process monitoring by sensors including complete system shutdown in an emergency situation
- With the residue drainage, process unlimited quantities fully automatically in unattended and continuous use: 24/7

# Automatic filling and emptying in two programs

## Sensor mode

### Flask filling and draining are monitored by sensors

- A sensor monitors the level in the evaporation flask
- The required level can be set individually
- Dosing is valve-controlled via the system vacuum
- A sensor monitors the stock of the mixture to be distilled and ends the process as soon as it is used up

## Time mode

### Control by entering individual time parameters

- The required level can be set individually
- The dosing is valve controlled by the system vacuum and occurs at fixed, preprogrammed time intervals
- The process is ended as soon as the predefined number of evaporation intervals has expired

Hei-VOLUME Distimatic	without residue drainage	with residue drainage
Glassware G9B	591-51000-00	591-53000-00
Glassware G9B XL	591-51000-02	591-53000-02

# Principle of Operation

## Hei-VOLUME Distimatic Benchtop

- Vacuum valve
  - Collector valve
  - Venting valve
  - Condensate pump
  - Residue pump
  - Dosing valve
- Sensor



	Hei-VOLUME Distimatic Benchtop without residue drainage	Hei-VOLUME Distimatic Benchtop 24/7 with residue drainage
<b>Compatibility</b>	Hei-VAP and Laborota 4000 series	Hei-VAP and Laborota 4000 series
<b>Display</b>	separate, digital	separate, digital
<b>Automatic feeding of the mixture</b>	yes	yes
<b>Automatic condensate removal</b>	yes	yes
<b>Automatic drainage of residue</b>	-	yes
<b>Power input</b>	max. 3,500 W	max. 3,500 W
<b>Weight</b>	5 kg	5 kg
<b>Dimensions without mounted components</b>	w/d/h 300×200×120 mm	300×200×120 mm
<b>Emergency stop switch</b>	yes	yes
<b>Degree of protection</b>	<b>EN 60529</b> IP 65 control panel and residue pump, IP 54 housing	IP 65 control panel and residue pump, IP 54 housing

# Vacuum Controller

## Manual Vacuum Controller

The cost-effective variant for vacuum regulation

- For control of existing diaphragm vacuum pumps or in-house vacuum
- Scale 0 to 1,000 mbar, divided into 50mbar steps
- The connection is designed for tubes with 8mm inside diameter
- Mounting on the evaporator itself is possible, a universal stand is included in the scope of delivery
- No vacuum valve required
- W/D/H 80×80×150 mm

P/N 591-26000-00



# Hei-VAC Vacuum Pumps

## Diaphragm vacuum pumps

- All parts in contact with the media have excellent chemical resistance thanks to the use of fluoropolymers throughout, from the vacuum to the discharge side
- The proven PTFE sandwich design leads to an above-average diaphragm life
- The head cover and spring washer have an additional stable core made of metal; this ensures excellent long-term stability
- The belt-free direct drive is free from wear parts and runs extremely quietly and with low-vibration
- The physically optimized gas ballast valve prevents condensation from forming in the pumps

The Buyer's Guide helps to identify the right vacuum source for the required application.

For more info visit [www.heidolph.com/knowledgeblog](http://www.heidolph.com/knowledgeblog)



## Hei-VAC Control

For precise vacuum regulation of the in-house vacuum or valve-controlled diaphragm vacuum pumps

- Affordable option for digital vacuum control
- Easy installation on the stay bar of the chiller or as a "standalone" device next to the evaporator
- Venting button to prevent foaming
- Graphic display of the vacuum process
- RS 232 interface
- Multi-lingual menu navigation
- Compatible with all Hei-VAP rotary evaporators, which do not have integrated vacuum control
- Complete with integrated ceramic diaphragm vacuum sensor, control and venting valve (control valve included in the scope of delivery), ready for use, with wall-plug power supply and manual

P/N 591-00360-00



## Fully-automatic regulation with speed control

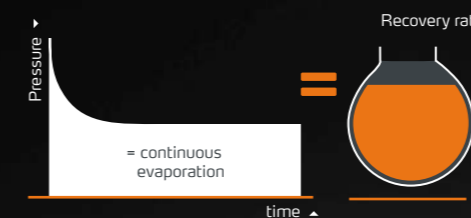

## Speed-controlled vacuum pumps

- Maximum distillation rates while reducing the process times by 30 %
- Solvent recovery up to 99 %
- As soon as the required set vacuum is reached, the pump stops automatically and keeps the vacuum reliably constant
- The minimal running achieves significant energy savings and increases the life of the diaphragm decisively
- These pumps ensure low-noise and low-vibration running
- Speed-controlled pumps achieve a vacuum with maximum possible precision

## Diaphragm Vacuum Pumps



### Hei-VAC Valve Tec For all Hei-VAP models

- Recommended for solvents within the low to medium boiling temperature range
- The vacuum regulation can be valve controlled or take place via the manual vacuum controller
- A vacuum valve is necessary if the vacuum pump is to be combined with the Hei-VAP Expert Control/Hei-VAP Ultimate Control

P/N 591-00160-00

### Rotavac Valve Control For all Hei-VAP models

- Sufficient intake capacity for three rotary evaporators simultaneously
- The vacuum regulation can be valve controlled or take place via the manual vacuum controller
- The vacuum pump can be switched on and off via the switchbox in line with needs
- A vacuum valve is necessary if the vacuum pump is to be combined with the Hei-VAP Expert Control/Hei-VAP Ultimate Control

P/N 591-00130-00

### Condenser

P/N 591-00083-00

	Hei-VAC Valve Tec	Rotavac Valve Control
Diaphragm vacuum pump	Two-stage	Two-stage
Intake capacity	0.75 m <sup>3</sup> /h	2.0 m <sup>3</sup> /h
Minimum end pressure	12 mbar	7 mbar
Combinable with condenser	yes	yes
Power input	80 W	180 W
Weight	6.0 kg	12.8 kg
Dimensions without condenser	w/d/h 145×315×185 mm	195×245×310 mm

## Speed-controlled Vacuum Pumps



### Hei-VAC Vario Tec For Hei-VAP Expert Control/ Ultimate Control models (direct adjustment via rotary evaporator)

- Recommended for solvents within the low to medium boiling temperature range

P/N 591-00171-00

### Hei-VAC Vario Control For Hei-VAP Expert Control/ Ultimate Control models (direct adjustment via rotary evaporator)

- Even if the gas ballast valve is open, a very good end vacuum is achieved when working with readily condensable vapors
- This enables the evaporation of high-boiling substances such as DMF or DMSO at low temperatures

P/N 591-00141-00

### Hei-VAC Vario Station Suitable for Hei-VAP Core models

- Independently controllable pump stand, consisting of vacuum pump and vacuum controller
- The pinpoint vacuum regulation prevents boiling delays and avoids sample loss
- Due to the automatic adjustment of the vacuum to the process parameters, time is gained for more important tasks

P/N 591-00142-00

### Condenser

P/N 591-00084-00

	Hei-VAC Vario Tec	Hei-VAC Vario Control	Hei-VAC Vario Station
Diaphragm vacuum pump	Two-stage	Three-stage	Three-stage
Intake capacity	1.0 m <sup>3</sup> /h	1.7 m <sup>3</sup> /h	1.7 m <sup>3</sup> /h
Minimum end pressure	12 mbar	2 mbar	5 mbar
Combinable with condenser	yes	yes	yes
Power input	160 W	160 W	160 W
Weight	4.3 kg	5.4 kg	6.0 kg
Dimensions without condenser	156×236×196 mm	167×236×196 mm	193×299×299 mm



# Hei-CHILL Recirculation Chillers

The recirculation chillers of the Hei-CHILL series are especially designed for reliable, continuous operation in the laboratory and production with cooling capacities from 250 to 1,200 W. Sealing problems are prevented by the magnetic coupling of pump and electric motor.

## Easy to use

- Clear control elements, large LED display and membrane keyboard as well as sight glass for checking the level of the coolant
- With a large refrigerant reservoir to compensate for performance peaks during the evaporation process



The Buyer's Guide helps to find the right cooling method for every need.  
For more info visit [www.heidolph.com/knowledgeblog](http://www.heidolph.com/knowledgeblog)

## Hei-CHILL 250

Compact design for positioning on the laboratory bench, cooling capacity 250 W

P/N 591-01600-00

## Hei-CHILL 350

Compact design for positioning on the laboratory bench, cooling capacity 350 W

P/N 591-01610-00

## Hei-CHILL 600

With casters for placing the chiller under the laboratory bench, cooling capacity 600 W

P/N 591-01620-00

## Hei-CHILL 1200

With casters for placing the chiller under the laboratory bench, cooling capacity 1,200 W

P/N 591-01630-00



## Accessories

### Kryo 30 liquid

Non-flammable coolant for Hei-CHILL recirculation chiller, 10 l

P/N 569-00611-00

20 l

P/N 569-00610-00



### RS 232 cable

For connecting a Hei-CHILL with a Hei-VAP Expert Control / Ultimate Control

P/N 14-007-040-72



### Enforced cooling tube

For cooling, inside Ø 9 mm, sold by the meter, for temperatures from -20 to +60 °C

P/N 591-38000-00

# Technical Specifications

## Recirculation chiller

Model	Hei-CHILL 250	Hei-CHILL 350	Hei-CHILL 600	Hei-CHILL 1200
Weight	28 kg	36 kg	52 kg	64 kg
Display	7-segment, LED	7-segment, LED	7-segment, LED	7-segment, LED
Temperature range	-10 – +40 °C	-10 – +40 °C	-10 – +40 °C	-10 – +40 °C
Coolant filling volume	2– 4 l	4– 7 l	4– 8 l	7– 14 l
Cooling capacity at +20 °C (20 °C ambient temperature)	250 W	350 W	600 W	1,200 W
Cooling capacity at 0 °C (20 °C ambient temperature)	150 W	200 W	360 W	750 W
Cooling capacity at -10 °C (20 °C ambient temperature)	90 W	120 W	150 W	400 W
Temperature constancy	±0.5 K	±0.5 K	±0.5 K	±0.5 K
Digital interface	RS 232	RS 232	RS 232	RS 232
Noise level	< 70 dB(A)	< 70 dB(A)	< 70 dB(A)	< 70 dB(A)
Reliable ambient temperature range storage	5–40 °C	5–40 °C	5–40 °C	5–40 °C
Max. delivery pressure	0.35 bar	0.35 bar	1.3 bar	1.3 bar
Max. flow rate	9 L/min	9 L/min	20 l / min	20 l / min
Overvoltage category	II	II	II	II
Alarm output connection	max. 30 V DC, 0.2 A	max. 30 V DC, 0.2 A	max. 30 V DC, 0.2 A	max. 30 V DC, 0.2 A
Degree of pollution	2	2	2	2
Distance from surroundings (front and back)	40 cm	40 cm	40 cm	40 cm
Classification to DIN 12876-1	I/NFL	I/NFL	I/NFL	I/NFL
Refrigerant	R-134a	R-134a	R-134a	R-134a
GWP (100a) to IPCC IV	1430	1430	1430	1430
Transport temperature range	-20 – +60 °C	-20 – +60 °C	-20 – +60 °C	-20 – +60 °C
Cooling	Air cooled device	Air cooled device	Air cooled device	Air cooled device
Standard supply voltage	230 V (50 Hz) or 115 V (60 Hz)	230 V (50 Hz) or 115 V (60 Hz)	230 V (50 Hz) or 115 V (60 Hz)	230 V (50 Hz) or 115 V (60 Hz)
Rated power input (230 V/115 V)	230 W/230 W	500 W/ 500 W	700 W/750 W	1,100 W/1,150 W
Cooling capacity	250 W	350 W	600 W	1,200 W
Dimensions w/d/h	200×350×465 mm	240×400×500 mm	350×480×595 mm	450×550×650 mm
Admissible permissible ambient conditions	5–31 °C at 80% rel. humidity, 32–40 °C decreasing linearly to max. 50% rel. humidity	5–31 °C at 80% rel. humidity, 32–40 °C decreasing linearly to max. 50% rel. humidity	5–31 °C at 80% rel. humidity, 32–40 °C decreasing linearly to max. 50% rel. humidity	5–31 °C at 80% rel. humidity, 32–40 °C decreasing linearly to max. 50% rel. humidity
Degree of protection	EN 60529 IP 32	IP 32	IP 32	IP 32

# Packages

## Hei-VAP Core



Allround Chill package

### BASIC

- Hei-VAP Core HL G3
- Hei-VAC Valve Tec
- Manual vacuum controller
- Tubing set

P/N 571-34300-00

### ALLROUND

- Hei-VAP Core HL G3
- Hei-VAC Control
- Hei-VAC Valve Tec
- Tubing set

P/N 571-20300-00

### ALLROUND CHILL

- Hei-VAP Core HL G3
- Hei-VAC Control
- Hei-VAC Valve Tec
- Hei-CHILL 250
- Tubing set
- Kryo 30 (10l)

P/N 571-21300-00

### UNIVERSITY ACADEMIC

- Hei-VAP Core HL G1
- Hei-VAC Valve Tec
- Manual vacuum controller
- Tubing set

P/N 571-24100-00

### UNIVERSITY ACADEMIC-CHILL

- Hei-VAP Core HL G1
- Hei-VAC Valve Tec
- Manual vacuum controller
- Hei-CHILL 250
- Tubing set
- Kryo 30 (10l)

P/N 571-25100-00

### ADVANCED EVAPORATION

- Hei-VAP Core ML G3
- Hei-VAC Vario Station
- Tubing set

P/N 572-36300-00

### LOW BOILING DRY ICE

- Hei-VAP Core ML G5B
- Hei-VAC Valve Tec
- Manual vacuum controller
- Tubing set

P/N 572-31550-00

## Packages

### Hei-VAP Expert Control



#### TWIN VAP

- 2x Hei-VAP Expert Control ML G3
- Rotavac Valve Control
- 2x vacuum valve
- Hei-CHILL 1200
- 2x tubing set
- Kryo 30 (20 l)
- 2x non-return valve
- 3xY-piece tube connectors

P/N 574-29300-00

## Packages

### Hei-VAP Ultimate Control



#### UNIVERSITY RESEARCH

- Hei-VAP Ultimate Control ML G3 XL
- Hei-VAC Vario Control
- Tubing set

P/N 576-26305-00

#### REACTION/ EXTRACTION

- Hei-VAP Expert Control ML G6
- Hei-VAC Vario Tec
- Vapor temperature sensor
- Tubing set

P/N 574-22600-00

#### POWDER DRYING

- Hei-VAP Expert Control ML G3
- Rotavac Valve Control
- Vacuum valve
- Tubing set
- Powder flask 2l
- Vapor tube with powder filter

P/N 574-32300-00

#### AUTOMATIC EVAPORATION

- Hei-VAP Expert Control ML G3
- Hei-VAC Vario Tec
- Condensate chiller for Rotavac Vario
- Tubing set
- Woulff bottle
- AUTO<sub>accurate</sub> sensor

P/N 574-37300-00

#### UNIVERSITY RESEARCH-CHILL

- Hei-VAP Ultimate Control ML G3 XL
- Hei-VAC Vario Control
- Hei-CHILL 600
- RS 232 Cable
- Tubing set
- Kryo 30 (10l)

P/N 576-27305-00

#### REACTION/ EXTRACTION-CHILL

- Hei-VAP Expert Control ML G6
- Hei-VAC Vario Tec
- Vapor temperature sensor
- Hei-CHILL 350
- RS 232 Cable
- Tubing set
- Kryo 30 (10l)

P/N 574-23600-00

#### POWDER DRYING-CHILL

- Hei-VAP Expert Control ML G3
- Rotavac Valve Control
- Vacuum valve
- Hei-CHILL 600
- RS 232 Cable
- Tubing set
- Powder flask 2l
- Vapor tube with powder filter
- Kryo 30 (10l)

P/N 574-33300-00

#### AUTOMATIC EVAPORATION PLUS

- Hei-VAP Expert Control ML G3B
- Hei-VAC Vario Control
- Condensate chiller for Rotavac Vario
- Tubing set
- Woulff bottle
- AUTO<sub>accurate</sub> sensor

P/N 574-38310-00



University Research-Chill Package

## Packages

### Hei-VOLUME Distimatic Benchtop



Distimatic Workstation 24 / 7

#### DISTIMATIC WORKSTATION 24 / 7

Complete package with vacuum pump and recirculation chiller, with residue drainage

- Hei-VAP Ultimate Control ML G9B XL
- Hei-VOLUME Distimatic **without** residue drainage
- Hei-CHILL 1200
- Kryo 30 (20l)
- RS 232 Cable
- Hei-VAC Vario Control
- Condensate cooler for Hei-VAC Vario Control
- Tubing set
- Heating bath liquid 5l
- Evaporation flask 5l

P/N 576-81915-00

#### DISTIMATIC INTEGRATION PACKAGE 24 / 7

For integration into an existing vacuum and cooling system, with residue cooling

- Hei-VAP Ultimate Control ML G9B XL (condensation surface 0.22 m<sup>2</sup>)
- Hei-VOLUME Distimatic **without** residue drainage for automated filling of the rotary flask and condensate drainage through a chemical diaphragm vacuum pump
- Tubing set for vacuum and cooling lines, chemical-resistant

P/N 576-83915-00

#### Hei-VOLUME Distimatic Benchtop packages without residue drainage

##### DISTIMATIC WORKSTATION

Like Distimatic Workstation 24/7, however, with Hei-VOLUME Distimatic **without** residue drainage

P/N 576-80915-00

##### DISTIMATIC INTEGRATION PACKAGE

Like Distimatic Integration Package 24/7, however, with Hei-VOLUME Distimatic **without** residue drainage

P/N 576-82915-00

## Hei-VAP Large-scale Evaporators Process large volumes easily and safely

Large-scale evaporators of the Hei-VAP Industrial series can be operated with up to 20 l flasks. The high standard of safety features and easy operation enable safe use, even by a single person.





## Leading Safety Standards

- Automatic cut-out of the rotation on opening the hood during ongoing operation
- The system switches off the relevant functions in the event of overpressure or overtemperature
- In case of an imminent hazard, the evaporator can be stopped immediately by an emergency stop button
- Automatic bath feeding with level control enables unattended evaporation – including at night, without having to worry about dry running
- The EASY LOCK flask fixing system makes the flask easier to change and prevents hazards
- The guard hood made of metal and safety glass reliably keeps out rising steam, splashing heating bath liquid and splinters in the event of glass breakage
- Operator panel with display of all safety-related functions that have to be met on commissioning
- Always up-to-date: USB interface enables software updates
- IQ-OQ acceptance and documentation possible



## Superior Ease of Use

- More flexibility and accessibility due to the optional base cart. The smooth-running casters make it possible to move the device for cleaning, assembly or for changing tubing
- With the touch display with a chemical-resistant glass surface, all parameters can be set easily and intuitively
- The adjustable EASY LOCK flask fixing system enables the evaporation flask to be changed by one person
- Processes can be controlled individually by free programming of pressure and temperature profiles. No repeated input of process parameters thanks to the storage of up to 999 ramps each with 250 steps
- Concealed heating coil and a drain valve ensure easy cleaning of the heating bath
- Drain valves in all receiving flasks for fast emptying
- In the event of sophisticated applications, readjustment is possible or the boiling point can be controlled automatically via the vacuum and steam temperature to prevent foaming and boiling delays
- The timer function ends the application automatically
- Automatic water bath feeding always ensures an optimal level in the heating bath





## Reduced Cost of Ownership

- The high quality increases the useful life to over 10 years on average while simultaneously reducing your maintenance and repair costs
- Whether water or oil: The universal heating bath is suitable for both. The system's unique tightness leads to a higher throughput with reduced energy consumption
- Distill unlimited quantities in unlimited continuous operation
- The automatic Hei-VOLUME Distimatic Pro module is an attractively priced alternative to conventional 50 or 100-liter evaporators and enables further process time and personnel savings
- The complete glassware as well as all accessory parts such as vacuum controller, vacuum valve, vacuum sensor and vapor temperature sensor are already included in the scope of delivery



MADE IN  
GERMANY

## All Benefits at a Glance

3-year warranty on all devices and an average operational lifespan of 10 years

## Intelligent Distillation

A factor of 3 times higher throughput compared to an 8h working day in manual operation

Automatic filling and refilling of the rotary flask, distillate and residue draining (in 24/7 packages), cleaning of the glass components and media-carrying tubes as well as automatic feed to the heating bath

Complete efficiency and safety in unattended and continuous use

Calibration-free sensors of the automatic module reliably detect any medium

Enabling and maintaining constant conditions for higher throughput

Automatic shutdown of all system components at the end of the process and in the event of a fault

Course of the process displayed with pictograms and colors for clear identification of process progress

Multilingual user interface

Individual process setting of the module through selectable operating modes (sensor, time, manual)

Easy cleaning of the heating bath thanks to concealed heating coil and drain valve

Cost-efficient alternative to 50l and 100l rotary evaporators

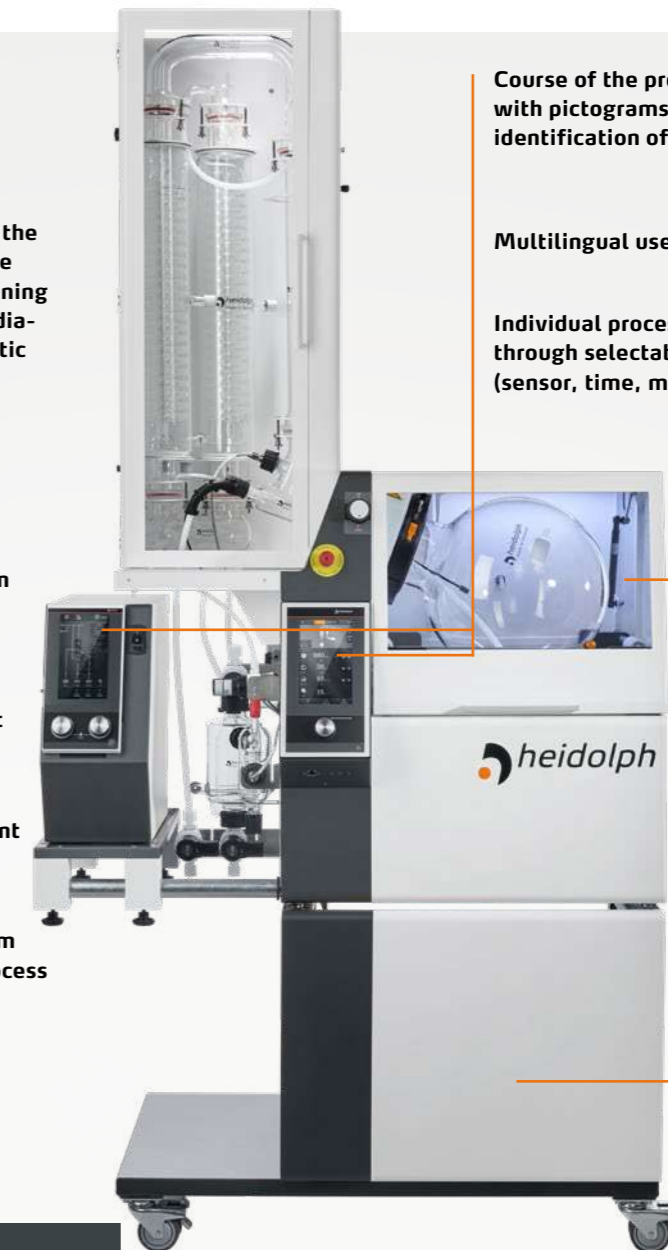

Base cart with casters (optional) for easy accessibility

# Hei-VAP Industrial

For enhanced vacuum control standards and for maximum safety

- Intuitive 7" touch display with all parameters in view
- With timer, ramp function and two programs for process control: SET<sub>pressure</sub> and AUTO<sub>accurate</sub>
- Full fitout incl. glassware, vacuum controller, vacuum valve, vacuum and vapor temperature sensor
- Easy and safe flask change with the EASY LOCK flask clamping system



Used in conjunction with the automatic Hei-VOLUME Distimatic Pro module with residue draining, processes can be completely automated, for unattended and continuous use, 24 / 7.

Maximum capacity with perfectly coordinated systems.

Discover the Hei-CHILL series online here.

Hei-VAP Industrial	P/N	Hei-VAP Industrial	P/N	Hei-VAP Industrial	P/N
Glassware A	518-13100-00	Glassware A2	518-14100-00	Glassware R	518-11100-00
Glassware AC	518-15100-00	Glassware A2C	518-16100-00	Glassware RC	518-12100-00
Glassware A1	518-14102-00	Glassware K	518-18102-00	Glassware Shorty R	518-18100-00
Glassware A1C	518-16102-00	Glassware KC	518-19102-00	Glassware Shorty RC	518-19100-00

# Programs for Vacuum Regulation

## Set<sub>pressure</sub>

For vacuum regulation for material separation

- This program is used to keep a required pressure constant
- Optionally, the course of the process can be predefined via ramps

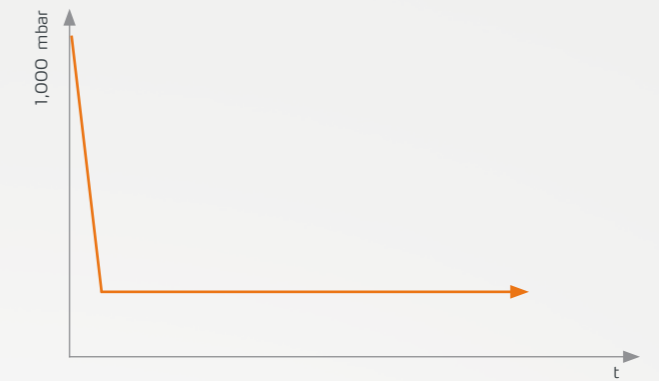

## AUTO<sub>accurate</sub>

For automatic vacuum regulation for the distillation of a solvent and solvent mixtures

- The required boiling points are found automatically by pressure lowering

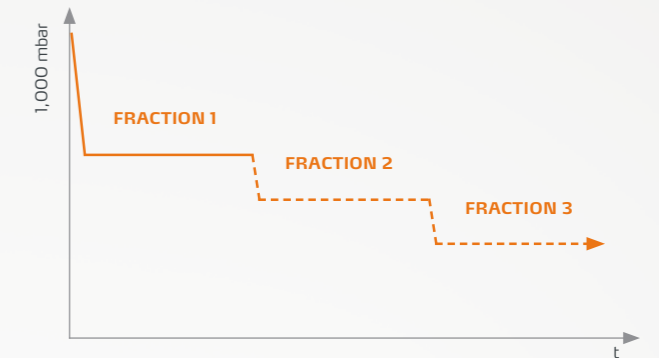

## Hei-VAP Industrial B

The functions of this model are exactly the same as those of the Hei-VAP Industrial, however, these safety-related aspects are reduced for limited budgets:

- Implosion protection hood above the evaporator flask
- PMMA protector in front of the glassware and in front of the receiving flask

Hei-VAP Industrial B	P/N	Hei-VAP Industrial B	P/N	Hei-VAP Industrial B	P/N
Glassware A	518-23100-00	Glassware A2	518-24100-00	Glassware R	518-21100-00
Glassware AC	518-25100-00	Glassware A2C	518-26100-00	Glassware RC	518-22100-00
Glassware A1	518-24102-00	Glassware K	518-28102-00	Glassware Shorty R	518-28100-00
Glassware A1C	518-26102-00	Glassware KC	518-29102-00	Glassware Shorty RC	518-29100-00

# Technical Specifications

## Hei-VAP Industrial

<b>Model</b>	<b>Hei-VAP Industrial / Hei-VAP Industrial B</b>	
<b>Speed range</b>	6–160 rpm	
<b>Rotation speed indicator</b>	digital	
<b>Display</b>	7" touch display	
<b>Lift</b>	Motor driven lift	
<b>Lifting speed</b>	45 mm/s	
<b>Lift travel</b>	180 mm	
<b>Motor</b>	EC motor	
<b>Heating power</b>	4,000 W	
<b>Temperature range heating bath</b>	20–180 °C	
<b>Heating bath setting accuracy</b>	±1 °C	
<b>Overtemperature protection</b>	110 (H <sub>2</sub> O) / 210 (oil)	
<b>Heating bath temperature display</b>	digital	
<b>Heating bath temperature control</b>	Microprocessor	
<b>Heating bath material</b>	Stainless steel V4A (1.4404)	
<b>Heating bath outside diameter</b>	400 mm	
<b>Heating bath volume</b>	24 (H <sub>2</sub> O) / 22 (oil)	
<b>Water bath level control</b>	automatically via water refill and level switch	
<b>Boiling temperature display</b>	digital	
<b>Required accessories</b>	Temperature sensor	
<b>Vapor temperature sensor display range</b>	0–200 °C (display accuracy 0.1 °C)	
<b>Vacuum controller integrated</b>	yes	
<b>Timer</b>	yes	
<b>Vacuum control mode, SET<sub>pressure</sub><sup>2</sup></b>	yes	
<b>Vacuum control mode, AUTO<sub>accurate</sub><sup>2</sup> requires AUTO<sub>accurate</sub> sensor</b>	yes	
<b>Programming of ramps</b>	yes	
<b>Recording of process data</b>	yes	
<b>Connected load</b>	4,600 W	
<b>Weight without glassware</b>	approx. 120 kg	
<b>Dimensions max.</b>	<b>w/d/h</b>	970 × 690 × 1,600 mm
<b>Evaporation rate<sup>1</sup> at 40 °C temperature difference</b>	Toluene	26.0 l/h
	Acetone	25.9 l/h
	Ethanol	12.9 l/h
	Water	4.7 l/h
<b>Maximum cooling surface</b>	1.2 m <sup>2</sup>	
<b>Permissible ambient conditions</b>	5–31 °C at 80 % rel. humidity, 32–40 °C linearly decreasing to max. 50 % rel. humidity	
<b>Protection class</b>	<b>DIN EN 60529</b>	IP 20

Standard supply voltage: 400 V three-phase d.c. current connection. Other supply voltages on request.

<sup>1</sup> ΔT = difference between heating bath temperature and boiling temperature

<sup>2</sup> Only possible in conjunction with vacuum systems

## Glassware Sets

One 20 l evaporator and one 10 l receiving flask each are already included in the scope of delivery of all glassware sets.

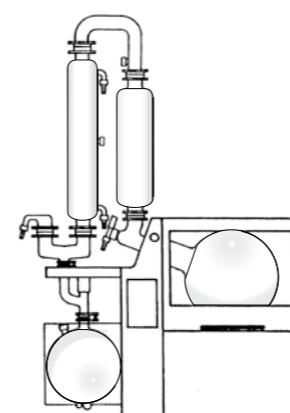

### Glassware A

For distillations of splashing and foaming substances. With a cooler and an expansion vessel

### Glassware AC

Like A, with additional receiving flask

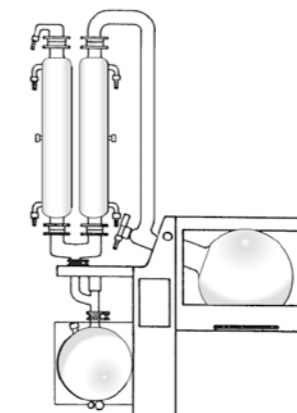

### Glassware A1

For low-boiling solvents and maximum distillation performances. With an ascending and a descending chiller as well as a riser tube

### Glassware A1C

Like A1, with additional receiving flask

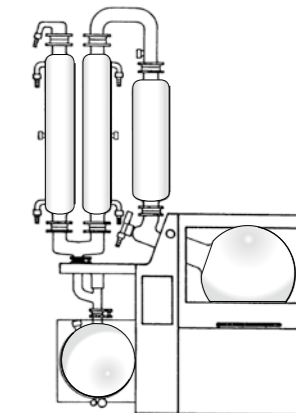

### Glassware A2

For distillations of splashing and foaming media with simultaneously high distillation performances. With an ascending and a descending chiller as well as an expansion vessel

### Glassware A2C

Like A2, with additional receiving flask

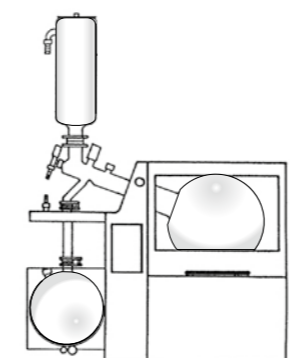

### Glassware K

Condensate traps for low-boiling solvents – cooling by dry ice

### Glassware KC

Like K, with additional receiving flask

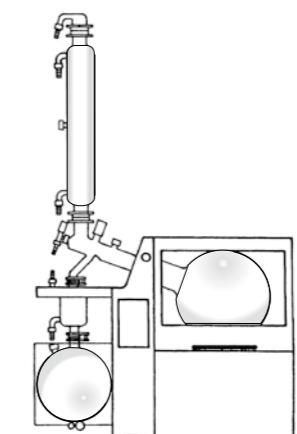

### Glassware R

Standard glassware for high-boiling distillation and reactions with non-return valve. With one chiller

### Glassware RC

Like R, with additional receiving flask

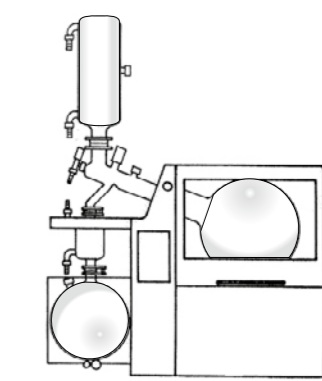

### Glassware Shorty R

For applications under fume hoods or in confined conditions. Same condensation surface as glassware R with 32 cm lower chiller height. With one chiller

### Shorty RC glassware

Like Shorty R, with additional receiving flask



## Accessories



### Evaporation flask

6 l  
P/N 15-300-003-23

10 l  
P/N 15-300-003-22

20 l  
P/N 15-300-003-21



### Powder flask

10 l  
P/N 15-300-003-24

20 l  
P/N 15-300-003-25

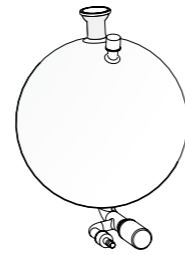

### Receiving flask

10 l, with drain valve 10 l;  
Included in the scope of delivery of all  
Hei-VAP Industrial models

P/N 15-300-004-11



### Boiling temperature sensor

Included in the standard scope of  
delivery of all Hei-VAP industrial models

P/N 14-014-003-06

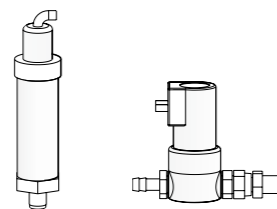

### Vacuum sensor

Included in the standard scope of  
delivery of all Hei-VAP industrial models

P/N 591-21000-00



### Tubing

For connection to vacuum and water,  
sold by the meter

P/N 591-33000-01

**Tubing set**  
with 16 m tube and tube clamps

P/N 591-34000-00

### Vacuum valve

Included in the standard scope of  
delivery of all Hei-VAP industrial models

P/N 591-20000-00



### Enforced cooling tube

For cooling, inside  $\varnothing$  9 mm,  
sold by the meter, for temperatures  
from  $-20$  to  $+60$  °C

P/N 591-38000-00



### Heating bath liquid

Heating bath liquid up to  $220$  °C (5 kg)

P/N 569-00600-00



### Base cart

For all Hei-VAP Industrial models

P/N 591-23000-00

## Vacuum Pump / Industrial Recirculation Chiller



### Rotavac 20 With condensate cooler

- For evacuating, evaporating and pumping away gases and vapors
- The pressure-side emission condenser enables almost 100 % recovery of solvents
- Excellent chemical and condensate compatibility
- Very low end vacuum of 2 mbar, very quiet, low-vibration operation
- Particularly high intake capacity of  $3.0$  m<sup>3</sup>/h
- Weight 19.9 kg, W/D/H 275×350×495 mm

P/N 591-07210-00

### Hei-CHILL 3000 Extensive range of services for challenging temperature control tasks with a cooling capacity of 3000 W

- Adjustable bypass for pressure limiting
- Fill opening at the top, drain tap at the rear
- Integrated program controller with 150 segments, can be divided between 5 programs
- Electronic level indicator and below level alarm
- SmartCool system for energy-saving digital cold control including automatic compressor function
- Clear, manageable controls, large TFT display and membrane keyboard
- USB interface and alarm contact as standard features

P/N 591-01700-00

### Hei-CHILL 5000, cooling capacity 5000 W P/N 591-01710-00

### WORKSTATION INDUSTRIAL FOR GLASSWARE R

For large-scale rotary evaporator systems with R-variant glassware sets (single condenser)

- Hei-CHILL 3000
- Kryo 30 (20l)
- Rotavac 20
- Tubing set

P/N 591-62000-00

### WORKSTATION INDUSTRIAL FOR GLASSWARE A

For large-scale rotary evaporator systems with A-variant glassware sets (single condenser)

- Hei-CHILL 5000
- Kryo 30 (20l)
- Rotavac 20
- Tubing set

P/N 591-64000-00

# Technical Specifications

## Vacuum pump/ Recirculation chiller/ Automatic module

For automatic module, see page 52

<b>Model</b>	<b>Rotavac 20</b>
<b>Diaphragm vacuum pump</b>	yes
<b>Intake capacity</b>	3.0 m <sup>3</sup> /h
<b>Minimum end pressure</b>	2 mbar
<b>Combinable with condensate coolers</b>	yes
<b>Power input</b>	250 W
<b>Weight</b>	19.9 kg
<b>Dimensions without glassware</b> <b>w/d/h</b>	350×275×495 mm

Model	Hei-CHILL 3000	Hei-CHILL 5000
<b>Cooling capacity at +20 °C<sup>1</sup></b>	3,000 W	5,000 W
<b>Cooling capacity at 0 °C<sup>1</sup></b>	1,680 W	2,750 W
<b>Cooling capacity at -10 °C<sup>1</sup></b>	1,030 W	1,700 W
<b>Cooling capacity at -20 °C<sup>1</sup></b>	600 W	1,000 W
<b>Temperature range</b>	-20 – +40 °C	-20 – +40 °C
<b>Accuracy temperature setting</b>	±0.05 K	±0.05 K
<b>Max. delivery pressure</b>	2 bar	2 bar
<b>Max. flow rate</b>	20 l/min	20 l/min
<b>Coolant filling volume</b>	20– 33 l	20– 33 l
<b>Dimensions</b> <b>w/d/h</b>	550 x 650 x 970 mm	550 x 650 x 970 mm

Model	Hei-VOLUME Distimatic Pro without residue drainage	Hei-VOLUME Distimatic Pro 24/7 with residue drainage
<b>Compatibility</b>	Hei-VAP Industrial	Hei-VAP Industrial
<b>Removable control panel</b>	yes	yes
<b>Display</b>	7" touch display, digital	7" touch display, digital
<b>Recording of process data (switched states)</b>	yes	yes
<b>Automatic feeding of the mixture</b>	yes	yes
<b>Automatic drainage of distillate</b>	yes	yes
<b>Automatic drainage of residue</b>	–	yes
<b>Emergency stop button</b>	On/Off switch, optional overpressure switch	On/Off switch, optional overpressure switch
<b>Rated voltage</b>	100–240 V AC; 50/60 Hz	100–240 V AC; 50/60 Hz
<b>Power input</b>	1,500 W max.	1,500 W max.
<b>Weight</b>	17 kg	17 kg
<b>Dimensions incl. control panel</b> <b>w/d/h</b>	186×429×521 mm	186×429×521 mm
<b>Permissible ambient conditions</b>	5–31 °C at 80 % rel. humidity, 32–40 °C linearly decreasing to max. 50 % rel. humidity 0–2,000 m above MSL,	5–31 °C at 80 % rel. humidity, 32–40 °C linearly decreasing to max. 50 % rel. humidity 0–2,000 m above MSL,
<b>Degree of protection</b> <b>EN 60529</b>	IP 42	IP 42

<sup>1</sup> 20 °C ambient temperature

# Packages

## Hei-VAP Industrial



### HEI-VAP INDUSTRIAL PERFORMANCE PLUS PACKAGE

Optimal for distillations of splashing and foaming substances

- Hei-VAP Industrial with Glassware A1C
- Base cart
- Tubing set (16 m)
- Rotavac 20
- Hei-CHILL 5000
- Kryo 30 (40l)

**P/N 518-46100-00**

### HEI-VAP INDUSTRIAL ALLROUND PACKAGE

For high-boiling distillation and reactions under reflux

- Hei-VAP Industrial with Glassware R
- Base cart
- Tubing set (16 m)
- Rotavac 20
- Hei-CHILL 3000
- Kryo 30 (40l)

**P/N 518-41100-00**

# Hei-VOLUME Distimatic Pro Industrial automatic module

**Saves time. Increases throughput. Reduces costs.**

The automatic HEI-VOLUME Distimatic Pro module enables full automation of the filling and emptying of a Hei-VAP Industrial large-scale evaporator.

**Real reduced workload through automation:**

- Filling and refilling of the rotary flask, distillate draining through overpressure, overpressure draining of the residue (in the 24/7 models) and cleaning program
- Automatic shutdown of all system components at the end of the process and in the event of a fault



**Very high usability:**

- Removable control panel with intuitive operation through rotary controller and 7" touch display
- Multi-lingual menu navigation for smooth setting and saving of process parameters
- Clear graphical display of the course of the process

**Efficiency and safety through smart sensors:**

- Increased distillation rates through constant conditions
- Calibration-free sensors detect any medium
- Individual process setting through selectable operating modes (sensor, time, manual)
- Safe operation day/night even unattended
- Space-saving and cost-efficient alternative to purchasing larger evaporator systems

Model	Hei-VOLUME Distimatic Pro	Hei-VOLUME Distimatic Pro 24/7
with adapter for	without drainage of residue	with drainage of residue
Glassware A series	591-61210-00	591-61110-00
Glassware R	591-61220-00	591-61120-00

Find out more about the automatic module at [www.hei-volume.com](http://www.hei-volume.com)

# Principle of Operation

Hei-VAP Industrial with Hei-VOLUME Distimatic Pro



## Accessories

### Hei-VOLUME Distimatic Pro Industrial



#### Heating tape set

**For heating the drainage tubing in order to easily remove viscous residues.**

Including plug-in card for Hei-VOLUME Distimatic Pro 24/7, heating tape 3.8 m, connection cable 2 m. Automatic detection and control by the Hei-VOLUME Distimatic Pro 24/7 module. Percentage adjustable, max. temperature 80 – 85 °C.

**P/N 591-65000-00**



#### Signal lights set

**Easy signaling of process states over larger distances.**

Including magnetic foot and plug-in card for Hei-VOLUME Distimatic Pro (including 24/7 variant). Signal light system provides information about the current system status at any time. Facilitated monitoring of multiple evaporator systems simultaneously.

**P/N 591-66000-00**

#### Signal lights plug-in card

For connecting an existing signal light or signal light column.

**P/N 11-300-008-52**



#### Emergency stop switch

For Hei-VOLUME Distimatic Pro (including 24/7 variant). External emergency stop switch for remote switching off of the device. Places the system and the peripherals in a safe process state. Connection via cable (2 m long).

**P/N 14-300-023-44**

## Accessories

### Hei-VOLUME Distimatic Pro Industrial



#### Carboys

Solvent-resistant carboys made of polyethylene. For use as a container for starting material, distillate or residue

**5 l**

**P/N 15-300-004-27**

**25 l**

**P/N 15-300-004-28**

**60 l**

**P/N 15-300-004-29**



#### Carboys with overflow sensor (distillate)

Carboys with integrated overpressure outlet and overflow sensor for the distillate (S8 sensor). Made of solvent-resistant polyethylene. For connecting the overflow sensor to the Hei-VOLUME Distimatic Pro (including 24/7 variant) control box. Detects when the carboy is full and stops the process to prevent overflowing.

**5 l**

**P/N 15-300-004-18**

**25 l**

**P/N 15-300-004-19**

**60 l**

**P/N 15-300-004-20**

#### Carboys with overflow sensors (residue)

As above, however, with overflow sensor for the residue (S9 sensor).

**5 l**

**P/N 15-300-004-21**

**25 l**

**P/N 15-300-004-22**

**60 l**

**P/N 15-300-004-23**

# Packages

## Hei-VAP<sup>3</sup> Pro Industrial

### All packages include:

- **Hei-VAP Industrial large-scale evaporator with base cart**

With 20 l rotary flask and automatic bath refill for unattended and continuous use. The base cart enables easy access and moving of the large-scale evaporator. It also ensures an optimal working height

- **Hei-VOLUME Distimatic Pro automatic module with adapter matching the glassware**

For automated filling of the rotary flask and for overpressure draining of the distillate and – for packages marked with “24/7” – draining of the residue



## Hei-VAP<sup>3</sup> Pro Industrial 24/7 Packages with automatic drainage of residue



### HEI-VAP<sup>3</sup> PRO INDUSTRIAL 24/7 FOAMING PACKAGE

#### With double condenser, especially for foaming media

- Glassware A2 for efficient evaporation and clean separation of foaming media; suitable for the most common solvents (incl. acetone, hexane, ethanol, water)
- Expansion vessel as foam brake
- One condenser each with descending and ascending condensation (condensation surface 1.2 m<sup>2</sup>)

P/N 518-14166-00

## Hei-VAP<sup>3</sup> Pro Industrial Packages without automatic drainage of residue

### HEI-VAP<sup>3</sup> PRO INDUSTRIAL HIGH BOILING PACKAGE

#### With single condenser, especially for high-boiling solvents

- Glassware R: for efficient evaporation of high-boiling solvents, e.g. xylene, DMF or DMSO
- With shut-off valve for operation of the rotary evaporator as a reflux reactor
- A condenser with ascending condensation (condensation surface 0.6 m<sup>2</sup>)

P/N 518-11163-00

### HEI-VAP<sup>3</sup> PRO INDUSTRIAL SOLVENT RECOVERY PACKAGE

#### With double condenser for maximum distillation performance of the most common solvents

- Glassware A1: for efficient evaporation and clean separation; suitable for the most common solvents (incl. acetone, hexane, ethanol, water)
- Riser tube for optimum separation
- One condenser with descending, one condenser with ascending condensation (condensation surface 1.2 m<sup>2</sup>)

P/N 518-14162-00

### HEI-VAP<sup>3</sup> PRO INDUSTRIAL 24/7 HIGH BOILING PACKAGE

#### With single condenser, especially for high-boiling solvents

- Glassware R: for efficient evaporation of high-boiling solvents such as xylene, DMF or DMSO
- With shut-off valve for operation of the rotary evaporator as a reflux reactor
- A condenser with ascending condensation (condensation surface 0.6 m<sup>2</sup>)

P/N 518-11165-00

### HEI-VAP<sup>3</sup> PRO INDUSTRIAL 24/7 SOLVENT RECOVERY PACKAGE

#### With double condenser for maximum distillation performance of the most common solvents

- Glassware A1: for efficient evaporation and clean separation; suitable for the most common solvents (incl. acetone, hexane, ethanol, water)
- Riser tube for optimum separation
- One condenser each with descending and with ascending condensation (condensation surface 1.2 m<sup>2</sup>)

P/N 518-14164-00



# Best Service

## For best results

Purchasing Heidolph Premium laboratory equipment is a decision for the leading quality, service and safety standards. **After process optimization and calibration procedure, it is also possible to ensure compliance with standards once defined and reliably reproducible results.**

To this end, Heidolph has different service packages set up in accordance with EN 13306:2018 with annual preventive service measures and extremely short response times for permanently reproducible processes. Service agreements offer the opportunity to decide for yourself which services help to optimize and secure processes.

### Before the purchase



#### Initial application counseling for all customers & interested parties

We address the individual requirements of your project, check the theoretical feasibility and find the best equipment combination for optimal results.



#### First application testing for all customers & interested parties

To test the theoretical feasibility, we perform a test with your original product in our laboratory. You will receive initial results on the process speed and quality of the sample.



#### Advanced application testing optional and individual

We offer additional tests in our laboratories, tailored to your requirements and given parameters. The costs are billed by the hour.



#### External analyses for verification

If you do not have the facilities for analyses, we can commission an external laboratory to do so. We determine viscosity, residual moisture and composition of your sample.

### After the purchase



#### Training Work successfully from day 1

After receiving your laboratory device, we support you with the commissioning and ensure optimal handling of the devices in individual application training sessions.



#### Optimal processes Maximum performance

Our application specialists adjust your installed new devices in an optimal and application-specific manner. We are also happy to help you to increase the performance of processes that are already running.

- Free
- Subject to a charge

 Detailed information and other services also available online on [www.heidolph.com](http://www.heidolph.com)

## Imprint

Publisher:  
Heidolph Instruments GmbH & Co. KG  
Walpersdorfer Straße 12, D – 91126 Schwabach

Edition: 01/2022

© Copyright 2021, Heidolph Instruments GmbH & Co. KG  
The reproduction of information or data requires our prior consent.

Illustrations may show accessories and decorative items that are not included in the scope of delivery.  
Technical changes & errors reserved.

Discover our rotary evaporators on  
[www.heidolph.com](http://www.heidolph.com)

---



**Heidolph Instruments GmbH & Co. KG**  
Walpersdorfer Str. 12 • 91126 Schwabach  
Phone: +49 9122 9920-67  
Fax: +49 9122 9920-65  
Email: [sales@heidolph.de](mailto:sales@heidolph.de)

 **heidolph**  
*research made easy*